

# ***Rockchip RK817 Datasheet***

**Revision 1.8  
Oct. 2021**

**Revision History**

<b>Date</b>	<b>Revision</b>	<b>Description</b>
2021-10-29	1.8	Update Power Sequence Description for default voltage of the off channel
2021-4-28	1.7	Update the description of RK817-2
2020-10-14	1.6	Update about VB_OK and RK817-5 description, figure Description, Vchrg_trick Description, Power Sequence Description
2020-03-05	1.5	Add Functional Block Diagram
2019-10-15	1.4	Update LDO3 and more detail information
2019-5-27	1.3	Update order information
2019-02-14	1.2	Add more detail description.
2018-8-28	1.1	Spec change @ power up sequence
2018-3-12	1.0	Initial release

## Table of Content

Table of Content .....	3
Figure Index .....	5
Table Index 6	
Warranty Disclaimer .....	7
Chapter 1 Introduction .....	8
1.1 Overview .....	8
1.2 Feature .....	9
1.3 Block Diagram .....	10
1.4 Typical Application Diagrams .....	11
Chapter 2 Package information .....	12
2.1 Ordering information .....	12
2.2 Top Marking .....	12
2.3 Dimension .....	13
2.4 Pin Assignment .....	14
2.5 Pinout Number Order .....	14
Chapter 3 Electrical Characteristics .....	17
3.1 Absolute Maximum Ratings .....	17
3.2 Recommended Operating Conditions .....	17
3.3 DC Characteristics .....	17
Chapter 4 Function Description .....	26
4.1 Top State Machine .....	26
4.1.1 State Machine Description .....	26
4.1.2 Power on Description .....	26
4.1.3 Power down Description .....	27
4.1.4 Reset Description .....	28
4.1.5 Power Sequence Description .....	30
4.1.6 Sleep Description .....	32
4.2 Power Channels .....	32
4.2.1 Buck Description .....	32
4.2.2 LDO Description .....	35
4.3 Switching Charger / Power Path / Boost /OTG .....	35
4.3.1 General Description .....	35
4.3.2 Charger Description .....	36
4.3.3 Power Path Description .....	37

4.3.4 Boost /OTG Description .....	37
4.4 Battery Gas Gauge .....	37
4.5 Audio System .....	39
4.5.1 General Description .....	39
4.5.2 Audio Recording Path Description .....	40
4.5.3 Head-Phone Path Description .....	40
4.5.4 Speaker Path Description .....	41
4.5.5 I2S Description .....	42
4.6 Others .....	42
4.6.1 Real Time Clock (RTC) Description .....	42
4.6.2 RC Oscillator Description .....	42
Chapter 5 Register Description .....	43
5.1 Register Summary .....	43
5.2 Register Description .....	48
Chapter 6 Thermal Management .....	136
6.1 Overview .....	136
6.2 Package Thermal Characteristics .....	136

## Figure Index

Fig. 1-1 RK817 Functional Block Diagram .....	10
Fig. 1-2 RK817 Typical Application Diagram .....	11
Fig. 2-1 QFN687mm X 7mm .....	13
Fig. 2-2 Pin Assignment QFN7x7-68(Pitch=0.35mm) .....	14
Fig. 4-1 State Machine .....	26
Fig. 4-2 Press "PWRON" key to turn on the PMIC .....	26
Fig. 4-3 USB plug in to turn on the PMIC .....	27
Fig. 4-4 Long press "PWRON" key to turn off the PMIC .....	27
Fig. 4-5 VSYS under-voltage to turn off the PMIC .....	28
Fig. 4-6 Long press "PWRON" key to restart the PMIC .....	29
Fig. 4-7 VSYS under-voltage to restart the PMIC .....	30
Fig. 4-8 BUCK1 load transient rising edge .....	33
Fig. 4-9 BUCK1 load transient falling edge .....	33
Fig. 4-10 BUCK1 load transient rising edge 2 .....	33
Fig. 4-11 BUCK1 load transient falling edge 2 .....	34
Fig. 4-12 BUCK1 efficiency curve when different input voltage .....	34
Fig. 4-13 BUCK2 efficiency curve when different input voltage .....	34
Fig. 4-14 BUCK3 efficiency curve when different input voltage .....	35
Fig. 4-15 BUCK4 efficiency curve when different input voltage .....	35
Fig. 4-16 Switching charger/ Power path/ Boost/ OTG architecture .....	36
Fig. 4-17 Charge curve .....	37
Fig. 4-18 Gas gauge architecture .....	38
Fig. 4-19 Current ADC Relative Error Curve .....	38
Fig. 4-20 Voltage ADC Relative Error Curve .....	39
Fig. 4-21 Audio system architecture .....	39
Fig. 4-22 Audio recording path THD+N ratio at differential mode .....	40
Fig. 4-23 Head-phone path THD+N ratio .....	41
Fig. 4-24 Speaker path THD+N ratio .....	42

## **Table Index**

Table 4-1 RK817-1Power up/down sequence(x:BUCK3 voltage determined by external divided resistor; LDO3 start up later than LDO1 for about 200uS) ,Short press PWRON key time is 500ms..... 30

Table 4-2 RK817-2Power up/down sequence(x:BUCK3 voltage determined by external divided resistor; LDO3 start up later than LDO1 for about 200uS) ,Short press PWRON key time is 500ms..... 31

Table 4-3 RK817-5Power up/down sequence(x:BUCK3 voltage determined by external divided resistor) ,Short press PWRON key time is 500ms. .... 32

Table 6-1 Thermal Resistance Characteristics ..... 136

Rockchip Confidential

## Warranty Disclaimer

Rockchip Electronics Co., Ltd makes no warranty, representation or guarantee (expressed, implied, statutory, or otherwise) by or with respect to anything in this document, and shall not be liable for any implied warranties of non-infringement, merchantability or fitness for a particular purpose or for any indirect, special or consequential damages.

Information furnished is believed to be accurate and reliable. However, Rockchip Electronics Co., Ltd assumes no responsibility for the consequences of use of such information or for any infringement of patents or other rights of third parties that may result from its use.

Rockchip Electronics Co., Ltd's products are not designed, intended, or authorized for using as components in systems intended for surgical implant into the body, or other applications intended to support or sustain life, or for any other application in which the failure of the Rockchip Electronics Co., Ltd's product could create a situation where personal injury or death may occur, should buyer purchase or use Rockchip Electronics Co., Ltd's products for any such unintended or unauthorized application, buyers shall indemnify and hold Rockchip Electronics Co., Ltd and its officers, employees, subsidiaries, affiliates, and distributors harmless against all claims, costs, damages, expenses, and reasonable attorney fees arising out of, either directly or indirectly, any claim of personal injury or death that may be associated with such unintended or unauthorized use, even if such claim alleges that Rockchip Electronics Co., Ltd was negligent regarding the design or manufacture of the part.

### Copyright and Patent Right

Information in this document is provided solely to enable system and software implementers to use Rockchip Electronics Co., Ltd 's products. There are no expressed or implied copyright licenses granted hereunder to design or fabricate any integrated circuits or integrated circuits based on the information in this document.

**Rockchip Electronics Co., Ltd does not convey any license under its patent rights nor the rights of others.**

**All copyright and patent rights referenced in this document belong to their respective owners and shall be subject to corresponding copyright and patent licensing requirements.**

### Trademarks

Rockchip and Rockchip™ logo and the name of Rockchip Electronics Co., Ltd's products are trademarks of Rockchip Electronics Co., Ltd. and are exclusively owned by Rockchip Electronics Co., Ltd. References to other companies and their products use trademarks owned by the respective companies and are for reference purpose only.

### Confidentiality

The information contained herein (including any attachments) is confidential. The recipient hereby acknowledges the confidentiality of this document, and except for the specific purpose, this document shall not be disclosed to any third party.

### Reverse engineering or disassembly is prohibited.

**ROCKCHIP ELECTRONICS CO., LTD. RESERVES THE RIGHT TO MAKE CHANGES IN ITS PRODUCTS OR PRODUCT SPECIFICATIONS WITH THE INTENT TO IMPROVE FUNCTION OR DESIGN AT ANY TIME AND WITHOUT NOTICE AND IS NOT REQUIRED TO UNDATE THIS DOCUMENTATION TO REFLECT SUCH CHANGES.**

### Copyright ©2021 Rockchip Electronics Co., Ltd.

All rights reserved. No part of this publication may be reproduced, stored in a retrieval system, or transmitted in any form or by any means, electric or mechanical, by photocopying, recording, or otherwise, without the prior written consent of Rockchip Electronics Co., Ltd.

## Chapter 1 Introduction

### 1.1 Overview

The RK817 is a complex power-management integrated circuit (PMIC) integrated CODEC for multi-core system applications powered by a Li-ion or a Li-ion polymer battery cell, or by a 5V input either from an USB port or from an adaptor. The RK817 can provide a complete power management solution with very few external components.

The RK817 provides four configurable synchronous step-down converters. The device also contains 9 LDO regulators, one switching-mode bi-direction charger, the power path management function, and a battery fuel gauge. Power-up/power-down controller is configurable and can support any customized power-up/power-down sequences (OTP based). A real-time clock (RTC) is also integrated to provide a 32.768-kHz output buffer, and real time function. The RK817 supports 32.768-kHz clock generation based on a crystal oscillator. It also includes Audio CODEC, real ground Head phone driver, Class-D driver, and Micro-phone input.

The RK817 integrates four channels step-down DC-DC converters. All of them adopt ripple base control to achieve very fast load transient response. Meanwhile, all of them can dynamically adjust the output voltage, as required by the processor based on the processor's operation status so as to maximize the system efficiency. The output voltages of most channels can be configured through the I2C interface. The inputs of all channels have soft start function, which greatly reduces the inrush current at the startup. 2.5MHz switching frequency and good control method decrease the external inductance and capacitance.

The RK817 integrates nine channels LDO regulators. The LDO3 is high PSRR (75dB @1Khz) high accuracy low drop-out regulator. The inputs of all LDO regulators could be decrease to 2V for high convert efficiency. The output voltages of all LDO regulators can be configured through the I2C interface.

The 2MHz switching-mode charger, together with the power path controller integrated in the RK817, allows supplying power to the loads while it is charging the battery. The charger provides functions such as input current limiting, trickle current charging, constant current (CC)/constant voltage (CV) charging, charging termination, charging over time protection, etc. All these functions can be conveniently configured through the I2C digital interface. When an input current limiting is triggered, the power path controller will distribute the input power in a way that the loads have the higher priority than the battery to take the input power. The difference between the input and output power will be used to charge the battery. In a case that the output power required by the loads exceeds the input power, the power path controller will automatically turn on the battery switch so that the battery can supply extra power to the loads together with the input supply. Other functions that the charger provides includes tiny current charging for an over discharged battery, or so called "dead battery", battery temperature monitoring, safe charging timer and over temperature shut down. Also, the switching-mode bi-direction charger could be used as boost converter, and "OTG" function is available.

A "battery fuel gauge" is also integrated in the RK817. Using the proprietary algorithms and the sensed battery current and voltage, the gauge can accurately calculate the battery capacity based on the charging/discharging characteristics of the battery preloaded in the system. The gauge then sends the battery capacity information to the processor through the I2C interface.

The RK817 also integrates complete audio system. The single end or differential mode Micro-phone can be connected to RK817 through two AC-couple capacitors. 24-bits ADC and gain adjustable PGA would convert the micro-phone signal to digital signal. The sound recording path has very low THD (-75dB @1KHz@580mV source). 24 bits DAC would convert digital signal to analog signal, and Class-AB driver adopt real-ground structure for Head-phone application, has very low THD (-90dB @1KHz@-3dBFS source). Meanwhile, Class-D driver integrated for speaker application. The speaker and head-phone can be used at the same time. I2S interface is integrated to communicate with processor.

The RK817 is available in a QFN68 7.0 mm x 7.0 mm package, with a 0.35-mm pin pitch.

## 1.2 Feature

- Input range: 3.8V – 5.5V for USB input; 2.7V - 5.5V for BAT input
- Low standby current of 16uA (at 32.768KHz clock frequency)
- Power channels:
  - ◆ BUCK1: 0.5V~2.4V, 2.5A max, very fast transient response
  - ◆ BUCK2: 0.5V~2.4V, 2.5A max, very fast transient response
  - ◆ BUCK3: 0.5V~2.4V (or resistor divider), 1.5A max, very fast transient response
  - ◆ BUCK4: 0.5V~3.4V, 1.5A max, very fast transient response
  - ◆ LDO1~LDO2,LDO4~LDO9: 0.6V~3.4V, 400mA max
  - ◆ LDO3: high PSRR (75dB @ 1KHz), 0.6V~3.4V, 100mA max
  - ◆ OTP Programmable power up/down sequences and voltage
- Switching mode Li-ion battery charger and power path management
  - ◆ Charger input current limit: 0.08A~3A
  - ◆ Charger to battery current: 0.5A~3.5A
  - ◆ Charger termination voltage: 4.1V~4.45V
  - ◆ Charger input voltage limit: 4.0V~4.7V
  - ◆ Constant temperature charge function
  - ◆ Over-temperature and Under-temperature protection / Charge time out protection
  - ◆ Power path controller with 4A current path with optional extended external mos
  - ◆ BOOST converter:2.1A max(Can not be used at the same time with the charger)
  - ◆ OTG Switch,2.1A max (Can not be used at the same time with the charger)
- Accurate battery fuel gauge with two separate battery voltage and current ADC
  - ◆ 16 bits ADC for battery voltage, battery temperature, USB/SYS voltage sense
  - ◆ 16 bits ADC for battery current sense
  - ◆ OCV algorithm combine with Coulom-counter algorithm
- Real time clock (RTC)
- Audio System
  - ◆ Audio codec: 24bits for both ADC and DAC
  - ◆ Support single end or differential mode Micro-phone input
  - ◆ Support real ground class-AB PA to drive Head-phone, 320hm Load
  - ◆ Support class-D PA to drive speaker, 1.3W
  - ◆ Support I2S as the digital signal interface for both DAC and ADC
  - ◆ Support programmable digital and analog gains
  - ◆ Sample rate: 48KHz~192KHz
  - ◆ Integrates internal PLL
  - ◆ Support PDM mode(external input PCLK)
- Package:7mmx7mm QFN68

### 1.3 Block Diagram

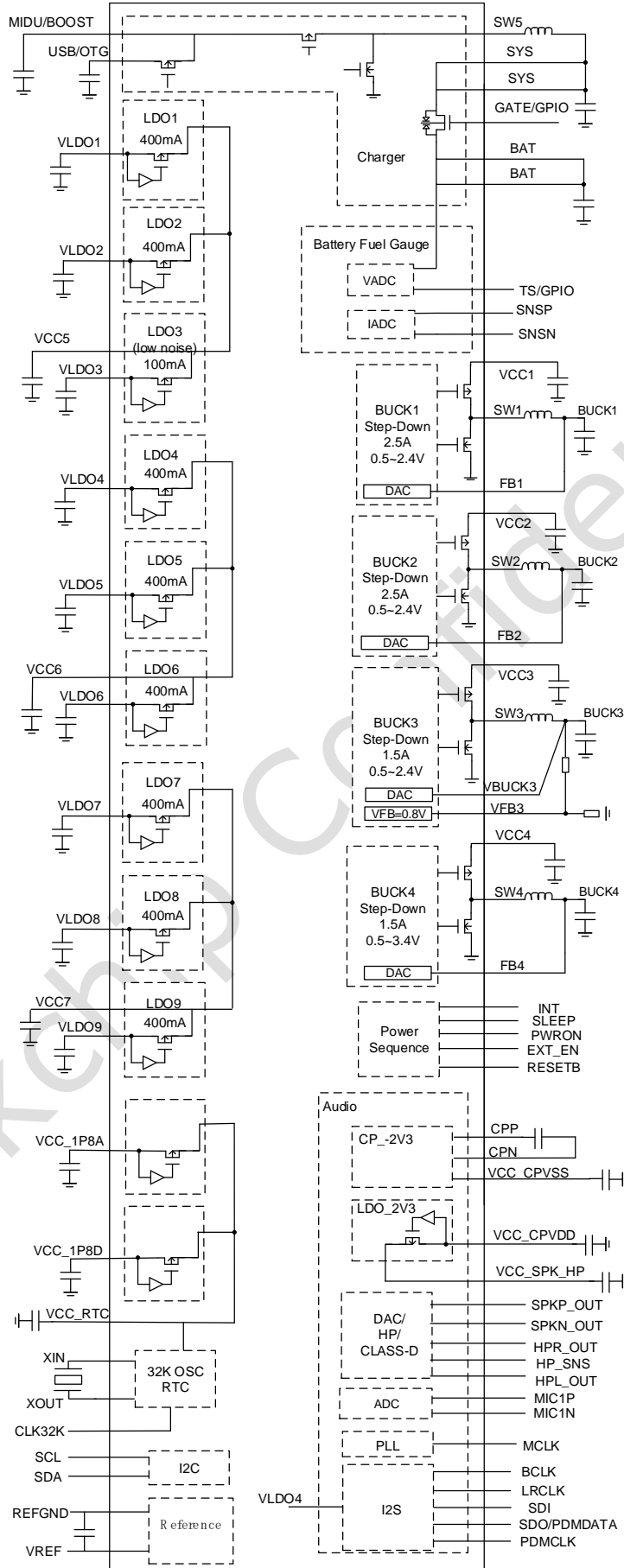

Fig. 1-1 RK817 Functional Block Diagram

Note: 1. The detail audio block diagram is shown at chapter "4.4 Audio System".  
 2. The I2S interface is internal pull high to VLDO4.

### 1.4 Typical Application Diagrams

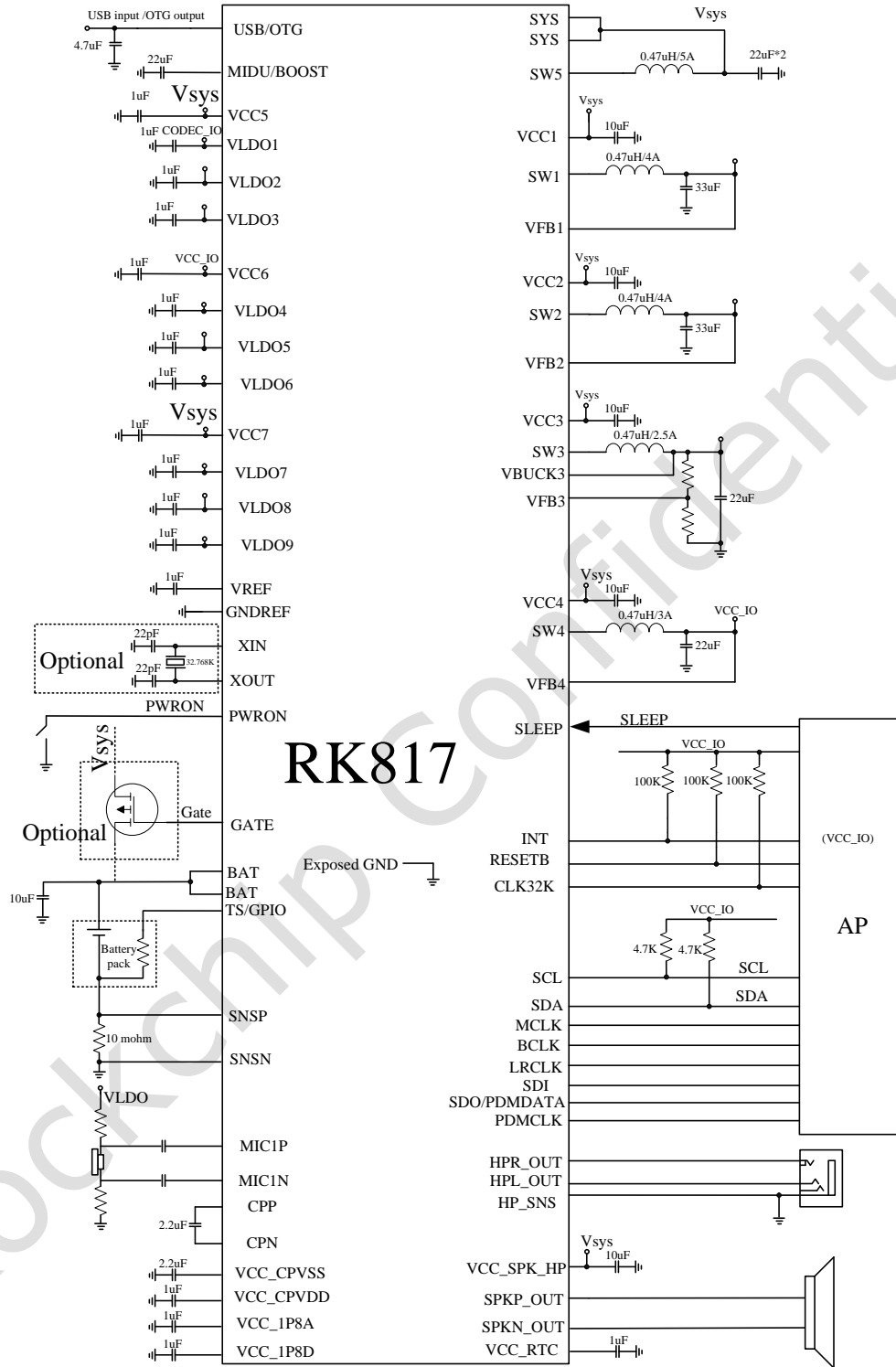

Fig. 1-2 RK817 Typical Application Diagram

## Chapter 2 Package information

### 2.1 Ordering information

Orderable Device	RoHS status	Package	Package Qty
RK817-1	RoHS	QFN68(7X7)	2000 pcs by reel
RK817-2	RoHS	QFN68(7X7)	2000 pcs by reel
RK817-5	RoHS	QFN68(7X7)	2000 pcs by reel

### 2.2 Top Marking

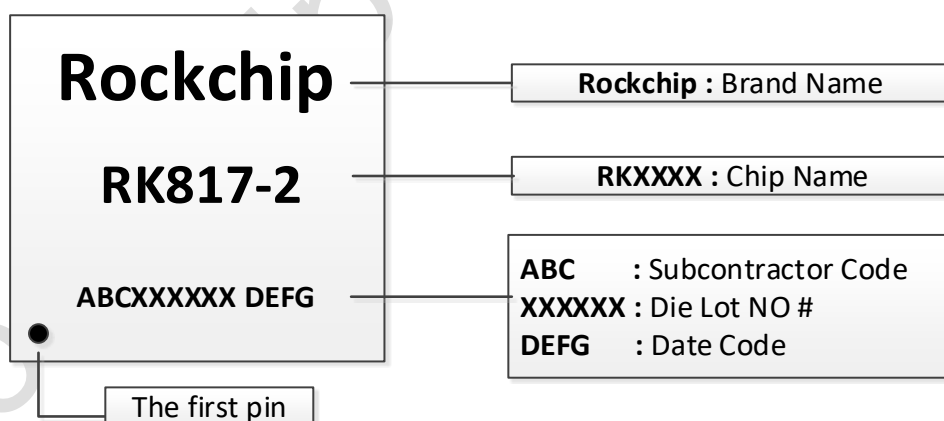
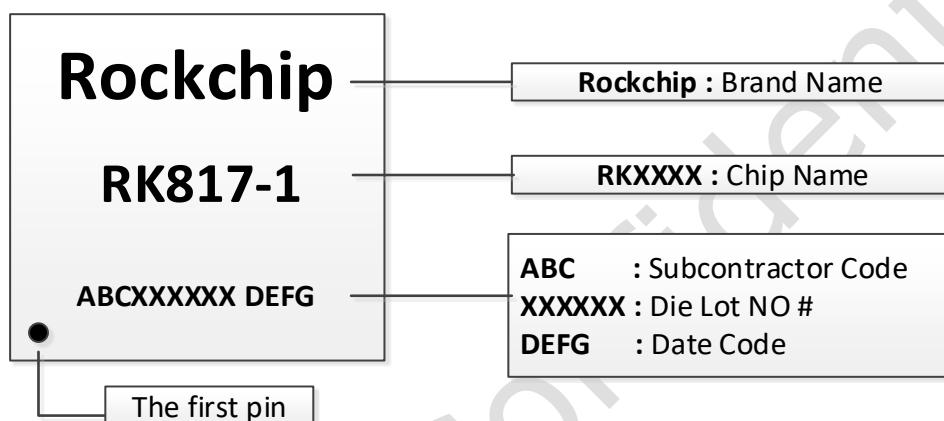



DESCRIPTION	SYMBOL	MILLIMETER		
		MIN	NOM	MAX
TOTAL THICKNESS	A	0.70	0.75	0.80
STAND OFF	A1	0	0.035	0.05
MOLD THICKNESS	A2	-	0.55	0.57
MATERIAL THICKNESS	A3	-	0.203 <sub>REF</sub>	-
PACKAGE SIZE	D	-	7 <sub>BSC</sub>	-
	E	-	7 <sub>BSC</sub>	-
EP SIZE	D1	5.39	5.49	5.59
	E1	5.39	5.49	5.59
LEAD LENGTH	L	0.30	0.4	0.50
LEAD PITCH	e	0.35 <sub>BSC</sub>		
LEAD WIDTH	b	0.1	0.15	0.2
LEAD OSITION OFFSET	aaa	0.07		
LEAD COPLANARITY	bbb	0.08		
PACKAGE EDGE PROFILE	ccc	0.10		
MOLD FLATNESS	ddd	0.10		
EP POSITION OFFSET	eee	0.10		
	fff	0.05		

Note:

1. Coplanarity applies to leads, corner leads and die attach pad.
2. Dimension b applies to metalized terminal and is measured between 0.15mm and 0.30mm from the terminal tip. If the terminal has the optional radius on the other end of the terminal, the dimension b should not be measure in that radius area.

## 2.4 Pin Assignment

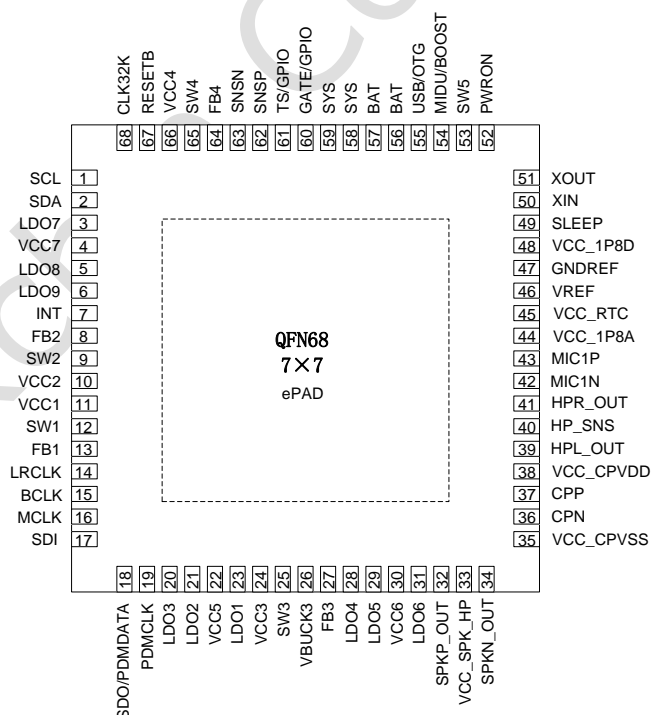

Fig. 2-2 Pin Assignment QFN7x7-68(Pitch=0.35mm)

## 2.5 Pinout Number Order

PIN NO	PIN NAME	PIN DESCRIPTION
1	SCL	I2C clock input
2	SDA	I2C data input and output(Open drain output)

PIN NO	PIN NAME	PIN DESCRIPTION
3	LDO7	LDO7 output
4	VCC7	Power supply of LDO7/8/9
5	LDO8	LDO8 output
6	LDO9	LDO9 output
7	INT	Interrupt request pin, open drain
8	FB2	Output feedback voltage of buck2
9	SW2	Switching node of buck2
10	VCC2	Power supply of buck2
11	VCC1	Power supply of buck1
12	SW1	Switching node of buck1
13	FB1	Output feedback voltage of buck1
14	LRCLK	The I2S framing clock
15	BCLK	The I2S bit clock
16	MCLK	The I2S main clock input pin
17	SDI	The I2S DAC input data
18	SDO/PDMDATA	The I2S ADC output data/PDM Data for the DSADC
19	PDMCLK	PDM CLK for the DSADC OUTPUT
20	LDO3	LDO3 output
21	LDO2	LDO2 output
22	VCC5	Power supply of LDO1/2/3
23	LDO1	LDO1 output
24	VCC3	Power supply of buck3
25	SW3	Switching node of buck3
26	VBUCK3	Output voltage of buck3
27	FB3	Output feedback voltage of buck3
28	LDO4	LDO4 output, internal power supply for I2S interface(Pin14~Pin19)
29	LDO5	LDO5 output
30	VCC6	Power supply of LDO4/5/6
31	LDO6	LDO6 output
32	SPKP_OUT	Positive speaker driver output
33	VCC_SPK_HP	Power supply for speaker and head phone
34	SPKN_OUT	Negative speaker driver output.
35	VCC_CPVSS	Negative power supply for the headphone
36	CPN	Negative switching node of the charger pump
37	CPP	Positive switching node of the charger pump.
38	VCC_CPVDD	Positive power supply for the headphone
39	HPL_OUT	Left channel output of the headphone
40	HP_SNS	Reference ground for the headphone
41	HPR_OUT	Right channel output of the headphone
42	MICIN	Negative input of the Microphone
43	MICIP	Positive input of the Microphone
44	VCC_1P8A	Power supply for internal 1.8V analog circuit
45	VCC_RTC	Power supply filter
46	VREF	Internal reference voltage
47	GNDREF	Reference ground
48	VCC_1P8D	Power supply for internal 1.8V digital circuit
49	SLEEP	Sleep mode control input
50	XIN	32.768KHz crystal oscillator input
51	XOUT	32.768KHz crystal oscillator output

PIN NO	PIN NAME	PIN DESCRIPTION
52	PWRON	Power on key input, active low, internal 17k resistor pull high to VCC_RTC
53	SW5	Switching node of charger/boost
54	MIDU/BOOST	Middle point of USB power supply / boost output
55	USB/OTG	USB power supply/OTG output
56,57	BAT	Positive battery terminal
58,59	SYS	DC-DC regulator output to power the system load and charge the battery
60	GATE/GPIO	Control the external PMOS to reduce the conduction resistance or GPIO function by register setting
61	TS/GPIO	Connect the thermistor from this pin to ground. Or it can be used as an analog input pin of internal ADC if the control bit is set to ADC function or GPIO function by register setting
62	SNSP	Bat charging and discharging sense current positive pin
63	SNSN	Bat charging and discharging sense current negative pin
64	FB4	Output feedback voltage of buck4
65	SW4	Switching node of buck4
66	VCC4	Power supply of buck4
67	RESETB	Reset pin after power on, active low;
68	CLK32K	32.768KHz clock output, open drain
Exposed pad	Exposed ground	Ground

## Chapter 3 Electrical Characteristics

### 3.1 Absolute Maximum Ratings

Parameter	Min	Max	Units
Voltage range on pins USB/OTG, MIDU/BOOST, SWx, VCC1~7,VCC_RTC,VCC_SPK_HP,LDOx, SYS, BAT, FBx,VBUCK3,SPKP_OUT,SPKN_OUT	-0.3	6.5	V
Voltage range on pin CLK32K,RESETB, SLEEP,SCL,SDA,INT,PWRON,XIN,SOUT, TS/GPIO,GATE/GPIO,	-0.3	6.5	V
Voltage range on pins LRCLK,BCLK,MCLK,SDI,SDO/PDMCLK,PDMCLK,	-0.3	6.5	V
Voltage range on pins SNSP,SNSN,VREF,VCC_1P8D,VCC_1P8A,MIC1N,MIC1P	-0.2	1.98	V
Voltage range on pins HP_SNS,HPR_OUT,HPL_OUT	-2.7	2.7	V
Voltage range on pins VCC_CPVDD,CPP	-0.3	2.7	V
Voltage range on pins VCC_CPVSS,CPN	-2.7	0.3	V
Storage temperature range, T <sub>S</sub>	-40	150	°C
Operating temperature range, T <sub>J</sub>	-40	125	°C
Maximum Soldering Temperature, T <sub>SOLDER</sub>		300	°C

Note:

Exposure to the conditions exceeded absolute maximum ratings may cause the permanent damages and affect the reliability and safety of both device and systems using the device. The functional operations cannot be guaranteed beyond specified values in the recommended conditions.

### 3.2 Recommended Operating Conditions

Parameter	Min	TYP	Max	Units
Voltage range on pins USB/OTG	4	5	5.5	V
Power Dissipation			2	W

### 3.3 DC Characteristics

Test conditions: BAT=4.0V,TA=25°C for typical values, unless otherwise noted.

PARAMETERS	SYMBOL	Note	MIN	TYP	MAX	UNIT	
<b>Power dissipation</b>							
Shut down Current	Isd			16	25	uA	
Power on current 1: All bucks, LDOs, ADC power on, Null load	Iq1			1.9		mA	
Power on current 2: buck1/buck4, LDO1/I <sub>do</sub> 2 power on, Null load	Iq2			0.65		mA	
Power on and sleep current: buck1/buck4, LDO1/I <sub>do</sub> 2 power on, low power mode, sleep mode, Null load	Isleep			0.19		mA	
<b>System Characteristics</b>							
VB_OK threshold, the battery voltage should be higher than it to	Vok	2.8V~3.6V by OTP programmed.	VB_OK_SEL[1:0]=0b01	2.744	2.8	2.856	V
			VB_OK_SEL[1:0]	2.94	3.0	3.06	V

PARAMETERS	SYMBOL	Note	MIN	TYP	MAX	UNIT	
power on the PMIC.			=0b00				
			VB_OK_SEL[1:0] =0b10	3.332	3.4	3.468	V
			VB_OK_SEL[1:0] =0b11	3.546	3.6	3.654	V
VB_UV threshold, when the SYS voltage is lower than it, The PMIC would be shutdown.	Vuv	2.7V~3.4V by I2C programmed. Typical is 2.7V.	VB_UV_SEL[2:0] =0b000	2.646	2.7	2.754	V
			VB_UV_SEL[2:0] =0b011	2.94	3.0	3.06	V
			VB_UV_SEL[2:0] =0b111	3.332	3.4	3.468	V
VB_LO threshold, when the SYS voltage is lower than it, The PMIC would be shut down or interrupt happen.	Vlo	2.8V~3.5V by I2C programmed. Typical is 3.2V.	VB_LO_SEL[2:0] = 0b000	2.744	2.8	2.856	V
			VB_LO_SEL[2:0] = 0b100	3.136	3.2	3.264	V
			VB_LO_SEL[2:0] = 0b111	3.43	3.5	3.57	V
VB_OV threshold, when the SYS voltage is higher than it, The PMIC would be shutdown.	Vov		5.3	5.4	5.5	V	
TSD threshold, when the temperature is higher than it, The PMIC would be shutdown.	Tsd	140/160°C by I2C programmed. Typical is 160°C.	TSD_TEMP=0b0	135	140	145	°C
			TSD_TEMP=0b1	155	160	165	°C
T warning threshold, when the temperature is higher than it, interrupt happen.	Twa	85~115°C by I2C programmed. Typical is 115°C.	HOTDIE_TEMP[1:0]=0b00	80	85	90	°C
			HOTDIE_TEMP[1:0]=0b01	90	95	100	°C
			HOTDIE_TEMP[1:0]= 0b10	100	105	110	°C
			HOTDIE_TEMP[1:0]= 0b11	110	115	120	°C
Long press PWRON key time	Tlp	6s~12s by I2C programmed. Typical is 6s.	PWRON_LP_OFF_TIME[1:0]=0b00		6		s
			PWRON_LP_OFF_TIME[1:0]=0b01		8		s
			PWRON_LP_OFF_TIME[1:0]=0b10		10		s
			PWRON_LP_OFF_TIME[1:0]=0b11		12		s
Short press PWRON key time	Tst	100ms/500ms by I2C programmed and OTP programmed. Typical is 500ms.	PWRON_ON_TIME=0b0		500		ms
			PWRON_ON_TIME=0b1		100		ms

**Test conditions: BAT=VCCx=4.0V, TA=25°C for typical values, unless otherwise noted.**

PARAMETERS	SYMBOL	Note	MIN	TYP	MAX	UNIT
<b>BUCK1: Fast load transient response step-down converter</b>						
Input supply voltage range	Vcc1		2.7		5.5	V
Output Voltage Accuracy @ all load @ all input voltage range	Vfb1	0.5V~2.4V by I2C programmed.	0.98	1.0	1.02	V

PARAMETERS	SYMBOL	Note	MIN	TYP	MAX	UNIT
		Typical is 1.0V. Step=12.5mV(0.5V~1.5V) Step=100mV(1.5V~2.4V)				
Load Transient Response L=0.47uH, Cout=32uF.	Vdrop1	0.25A to 2.5A, 0.5A/uS, Vout=1V		20		mV
Rated output current	Imax1		2.5			A
Switching Frequency when CCM mode	Fsw1	Vin-Vout>1.5V	2.25	2.5	2.75	MHz
Conversion Efficiency (Vin=4.2V,Vout=1V)		Iout=2A Iout=1A Iout=0.3A		75 82 85		%
<b>BUCK2: Fast load transient response step-down converter</b>						
Input supply voltage range	Vcc2		2.7		5.5	V
Output Voltage Accuracy @ all load @ all input voltage range	Vfb2	0.5V~2.4V by I2C programmed. Typical is 1.0V. Step=12.5mV(0.5V~1.5V) Step=100mV(1.5V~2.4V)	0.98	1.0	1.02	V
Load Transient Response L=0.47uH, Cout=32uF.	Vdrop2	0.25A to 2.5A, 0.5A/uS, Vout=1V		20		mV
Rated output current	Imax2		2.5			A
Switching Frequency when CCM mode	Fsw2	Vin-Vout>1.5V	2.25	2.5	2.75	MHz
Conversion Efficiency (Vin=4.2V,Vout=1V)		Iout=2A Iout=1A Iout=0.3A		75 82 85		%
<b>BUCK3: Fast load transient response step-down converter</b>						
Input supply voltage range	Vcc3		2.7		5.5	V
Feedback Voltage, Default	Vfb3	Selection of external resistor divider	0.784	0.8	0.816	V
Output Voltage Accuracy @ all load @ all input voltage range	Vbuck3	If internal divide mode selected: 0.5V~2.4V by I2C programmed. Typical is 1.25V. Step=12.5mV (0.5V~1.5V) Step=100mV (1.5V~2.4V)	1.225	1.25	1.275	V
Load Transient Response L=0.47uH, Cout=22uF.	Vdrop3	0.15A to 1.5A, 0.5A/uS, Vout=1.25V		17		mV
Rated output current	Imax3		1.5			A
Switching Frequency when CCM mode	Fsw3	Vin-Vout>1.5V	2.25	2.5	2.75	MHz
Conversion Efficiency (Vin=4.2V,Vout=1.25V)		Iout=1A Iout=0.3A		82 83		%
<b>BUCK4: Fast load transient response step-down converter</b>						
Input supply voltage range	Vcc4		2.7		5.5	V
Output Voltage Accuracy @ all load @ all input voltage range	Vfb4	0.5V~3.4V by I2C programmed. Typical is 3V. Step=12.5mV (0.5V~1.5V) Step=100mV (1.5V~3.4V)	2.94	3	3.06	V

PARAMETERS	SYMBOL	Note	MIN	TYP	MAX	UNIT
Load Transient Response L=0.47uH, Cout=22uF.	Vdrop4	0.15A to 1.5A, 0.5A/uS, Vout=3V		22		mV
Rated output current	Imax4		1.5			A
Switching Frequency when CCM mode	Fsw4	Vin-Vout>1.5V	2.25	2.5	2.75	MHz
Conversion Efficiency (Vin=4.2V,Vout=3V)		Iout=1A Iout=0.3A		92 93		%
<b>LDO1</b>						
Input supply voltage range	Vcc5		2		5.5	V
Output Voltage Accuracy @ all load @ all input voltage range	Vldo1	0.6V~3.4V by I2C programmed. Typical is 1V. Step=25mV	0.98	1	1.02	V
Rated output current	Imax1	Vcc5- Vldo1>0.4V	400			mA
		Vcc5- Vldo1>0.2V	200			mA
PSRR@ 1KHz		Vin rms=200mV		65		dB
PSRR@ 10KHz		Vin rms=200mV		60		dB
<b>LDO2</b>						
Input supply voltage range	Vcc5		2		5.5	V
Output Voltage Accuracy @ all load @ all input voltage range	Vldo2	0.6V~3.4V by I2C programmed. Typical is 1.8V. Step=25mV	1.764	1.8	1.836	V
Rated output current	Imax12	Vcc5- Vldo2>0.4V	400			mA
		Vcc5- Vldo2>0.2V	200			mA
PSRR@ 1KHz		Vin rms=200mV		65		dB
PSRR@ 10KHz		Vin rms=200mV		60		dB
<b>LDO3: High PSRR LDO</b>						
Input supply voltage range	Vcc5		2		5.5	V
Output Voltage Accuracy @ all load @ all input voltage range	Vldo3	0.6V~3.4V by I2C programmed. Typical is 1V. Step=25mV	0.98	1	1.02	V
Rated output current	Imax13	Vcc5- Vldo3>0.4V	100			mA
		Vcc5- Vldo3>0.2V	50			mA
PSRR@ 1KHz		Vin rms=200mV		75		dB
PSRR@ 10KHz		Vin rms=200mV		70		dB
<b>LDO4</b>						
Input supply voltage range	Vcc6		2		5.5	V
Output Voltage Accuracy @ all load @ all input voltage range	Vldo4	0.6V~3.4V by I2C programmed. Typical is 3V. Step=25mV	2.94	3	3.06	V
Rated output current	Imax14	Vcc6- Vldo4>0.4V	400			mA
		Vcc6- Vldo4>0.2V	200			mA
PSRR@ 1KHz		Vin rms=200mV		65		dB
PSRR@ 10KHz		Vin rms=200mV		60		dB
<b>LDO5</b>						
Input supply voltage range	Vcc6		2		5.5	V
Output Voltage Accuracy @ all load @ all input voltage range	Vldo5	0.6V~3.4V by I2C programmed. Typical is 3V. Step=25mV	2.94	3	3.06	V
Rated output current	Imax15	Vcc6- Vldo5>0.4V	400			mA
		Vcc6- Vldo5>0.2V	200			mA
PSRR@ 1KHz		Vin rms=200mV		65		dB
PSRR@ 10KHz		Vin rms=200mV		60		dB
<b>LDO6</b>						
Input supply voltage range	Vcc6		2		5.5	V
Output Voltage Accuracy @ all load @ all input voltage range	Vldo6	0.6V~3.4V by I2C programmed. Typical is 3V.	2.94	3	3.06	V

PARAMETERS	SYMBOL	Note	MIN	TYP	MAX	UNIT
Rated output current	Imaxl6	Step=25mV Vcc6- Vldo6>0.4V	400			mA
		Vcc6- Vldo6>0.2V	200			mA
PSRR@ 1KHz		Vin rms=200mV		65		dB
PSRR@ 10KHz		Vin rms=200mV		60		dB
<b>LDO7</b>						
Input supply voltage range	Vcc7		2		5.5	V
Output Voltage Accuracy @ all load @ all input voltage range	Vldo7	0.6V~3.4V by I2C programmed. Typical is 2.8V. Step=25mV	2.744	2.8	2.856	V
Rated output current	Imaxl7	Vcc7- Vldo7>0.4V	400			mA
		Vcc7- Vldo7>0.2V	200			mA
PSRR@ 1KHz		Vin rms=200mV		65		dB
PSRR@ 10KHz		Vin rms=200mV		60		dB
<b>LDO8</b>						
Input supply voltage range	Vcc7		2		5.5	V
Output Voltage Accuracy @ all load @ all input voltage range	Vldo8	0.6V~3.4V by I2C programmed. Typical is 1.8V. Step=25mV	1.764	1.8	1.836	V
Rated output current	Imaxl8	Vcc7- Vldo8>0.4V	400			mA
		Vcc7- Vldo8>0.2V	200			mA
PSRR@ 1KHz		Vin rms=200mV		65		dB
PSRR@ 10KHz		Vin rms=200mV		60		dB
<b>LDO9</b>						
Input supply voltage range	Vcc7		2		5.5	V
Output Voltage Accuracy @ all load @ all input voltage range	Vldo9	0.6V~3.4V by I2C programmed. Typical is 1.5V. Step=25mV	1.47	1.5	1.53	V
Rated output current	Imaxl9	Vcc7- Vldo9>0.4V	400			mA
		Vcc7- Vldo9>0.2V	200			mA
PSRR@ 1KHz		Vin rms=200mV		65		dB
PSRR@ 10KHz		Vin rms=200mV		60		dB

**Test conditions: VUSB=5V, BAT=4.0V, TA=25°C for typical values, unless otherwise noted.**

PARAMETERS	SYMBOL	Note	MIN	TYP	MAX	UNIT	
<b>Switching mode charger</b>							
USB Operating Range	Vusb		3.8	5	5.5	V	
USB Input Current Limit	Iusb_lmt	0.08A~3A by I2C programmed. Typical is 0.45A.	USB_ILIM_SEL [2:0]=0b000	0.4	0.45	0.5	A
			USB_ILIM_SEL [2:0]=0b011		1.5		A
			USB_ILIM_SEL [2:0]=0b111		3		A
USB input Voltage Limit	Vusb_lmt	4V~4.7V by I2C programmed. Typical is 4.4V	USB_VLIM_SEL [2:0]=000	3.92	4	4.08	V
			USB_VLIM_SEL [2:0]=100	4.31 2	4.4	4.488	V
			USB_VLIM_SEL [2:0]=111	4.60 6	4.7	4.794	V
Charge constant current	Ichrg_cc	0.5A~3.5A by I2C programmed. Typical is 2A.	CHRG_CUR_SE L[2:0]=0b000		1		A
			CHRG_CUR_SE L[2:0]=0b010	1.9	2	2.1	A

PARAMETERS	SYMBOL	Note	MIN	TYP	MAX	UNIT
				3.5		A
Charge constant voltage	Vchrg_cv	4.1V~4.45V by I2C programmed. Typical is 4.2V.		4.1		V
			4.18	4.2	4.22	V
				4.45		V
Trickle charge current	Ichrg_trick	Ichrg_cc>=2A	150	200	250	mA
		Ichrg_cc<2A	70	100	130	mA
Dead charge current	Ichrg_dead		50	80	110	mA
Charge terminal current	Ichrg_term	Analog mode: 0.15A~0.4A by I2C programmed. Typical is 0.2A.		150		mA
			150	200	250	mA
				400		mA
		Digital mode (by ADC sense): 4mA~1A by I2C programmed. Typical is 0.2A.	190	200	210	mA
Charge time out @CCCV mode	Tchrg_cccv	4h~16h by I2C programmed. Typical is 6h.		4		h
				6		h
				16		h
Charge time out @Trickle mode	Tchrg_trick	30min~180min by I2C programmed. Typical is 60min.		30		Min
				60		Min
				210		Min
Trickle charge Maximum Voltage: when battery voltage is higher than it, charge state goes to CCCV mode	Vchrg_trick			3.0		V
Dead charge Maximum Voltage: when battery voltage is higher than it, charge state goes to Trickle mode	Vchrg_dead			2		V
<b>Power Path</b>						
Dis-Charge current limit	Idis	2A~4A by I2C programmed. Typical is 3A.		2		A
			2.9	3	3.1	A
				4		A
SYS short current		SYS short		200		mA

PARAMETERS	SYMBOL	Note	MIN	TYP	MAX	UNIT	
protection							
Rdson of power path mos		ISYS=200mA, VBAT=4.2V		100	120	mΩ	
<b>Boost/OTG</b>							
Input supply voltage range of Boost	Vsys		2.7		4.4	V	
Output Voltage Accuracy of Boost @ all load @ all input voltage range	Vmidu	4.7V~5.4V by I2C programmed. Typical is 5V.	BOOST_ON_V SEL[2:0]=0b000		4.7	V	
			BOOST_ON_V SEL[2:0]=0b011	4.9	5	5.1	V
			BOOST_ON_V SEL[2:0]=0b111		5.4		V
Rated output current of Boost	Imax5		2.1			A	
Rdson_of OTG				90		mΩ	
Rated output current of OTG	Imax6		2.1			A	

**Test conditions: VUSB=5V, BAT=4.0V, TA=25°C for typical values, unless otherwise noted.**

<b>A/D CONVERTER</b>						
Voltage measuring ADC resolution				16		bits
Voltage measuring ADC accuracy			-0.5%		+0.5%	%
Range of USB/OTG voltage measurement			1		6	V
Range of BAT voltage measurement			0		4.6	V
Range of SYS voltage measurement			1		6	V
Range of TS voltage measurement			0		1.2	V
Current measuring ADC resolution		MSB is sign bit		16		bits
Current measuring ADC accuracy		ABS(Ibat)>0.2A	-0.5%		+0.5%	%
Range of Current ADC measurement		SNSP/SNSN sense resistor=10mOhm	-5.625		5.625	A
Coulom-counter range				32		bits
Coulom-counter accuracy		ABS(Ibat)>0.2A	-1		+1	%

**Test conditions: VCC\_SPK=5V, BAT=4.0V, TA=25°C for typical values, unless otherwise noted.**

PARAMETERS	SYMBOL	Note	MIN	TYP	MAX	UNIT
<b>ClassD Audio PA</b>						
Input supply voltage range	Vccspk	VCC_SPK_HP	2.7		5.5	V
THD+N		1KHz, Po=0.4Wrms, VCC_SPK_HP =3.8V		0.1		%
RMS Power		8 ohm load, VCC_SPK_HP =3.8V, THD+N=1%		700		mW
		8 ohm load, VCC_SPK_HP		1100		mW

PARAMETERS	SYMBOL	Note	MIN	TYP	MAX	UNIT
		=5V, THD+N=1%				
		8 ohm load, VCC_SPK_HP =5V, THD+N=10%		1300		mW
PSRR		217Hz, VCC_SPK_HP =200mVpk- pk+3.8V,		65		dB
Output Offset Voltage		VCC_SPK_HP =3.8V	- 15		+ 15	mV
Noise Level		VCC_SPK_HP =3.8V 0dB Gain, 8ohm, A-weighted		100		uV
Efficiency		VCC_SPK_HP =3.8V,0.4W,8ohm with 68uH, 1KHz		88		%
Quiescent current		No load, VCC_SPK_HP =3.8		4		mA
<b>DAC to Head phone outputs</b>						
Full scale output level		RL=32ohm		0.5		Vrms
		RL=300ohm		0.8		Vrms
Signal to Noise Ratio	SNR	A-weighted RL=32ohm, - 60dBFS, Fs=48KHz		97		dB
Total Harmonic Distortion + Noise	THD+N	A-weighted RL=32ohm - 3dBFS Fs=48KHz		-75		dB
<b>Micro-phone to ADC stereo input</b>						
Full sale input voltage				0.8		Vrms
Input common voltage	V <sub>COMN</sub>			0.9		V
SNR		A-weighted, - 60dBFS,Fs=48KH z		88		dB
THD+N		A-weighted 997Hz -3dBFS Differential input signal, Fs=48KHz		-75		dB

**Test conditions: BAT=4.0V, TA=25°C for typical values, unless otherwise noted.**

PARAMETERS	SYMBOL	Note	MIN	TYP	MAX	UNIT
<b>I2C interface (7bits I2C address is 0x20)</b>						
SCL clock frequency	f <sub>SCL</sub>				1000	KHz
<b>LOGIC INPUT</b>						
Input LOW-Level Voltage	V <sub>IL</sub>				0.4	V
Input HIGH-Level Voltage: LRCLK,BCLK,MCLK,SDI,PDMCLK	V <sub>IH1</sub>		VLDO4* 0.7		VCC_RT C	V
Input HIGH-Level Voltage: SCL,SDA,SLEEP,PWRON,TS/GPI O,GATE/GPIO,RESETB	V <sub>IH2</sub>		VCC_1P 8D*0.7		VCC_RT C	V
<b>LOGIC OUTPUT</b>						
LOW-Level Output Voltage, 3.0 mA sink current	V <sub>OL</sub>				0.4	V
HIGH-Level Output Voltage, 3.0 mA source current: LRCLK,BCLK,SDO/PDMDATA	V <sub>OH1</sub>		VLDO4- 0.4		VLDO4	V

PARAMETERS	SYMBOL	Note	MIN	TYP	MAX	UNIT
HIGH-Level Output Voltage, 3.0 mA source current: TS/GPIO,GATE/GPIO	V <sub>OH2</sub>		VCC_RT C-0.4		VCC_RT V	V
<b>OPEN DRAIN OUTPUT PIN</b>						
CLK32K,RESETB,INT,SDA						

Rockchip Confidential

## Chapter 4 Function Description

### 4.1 Top State Machine

#### 4.1.1 State Machine Description

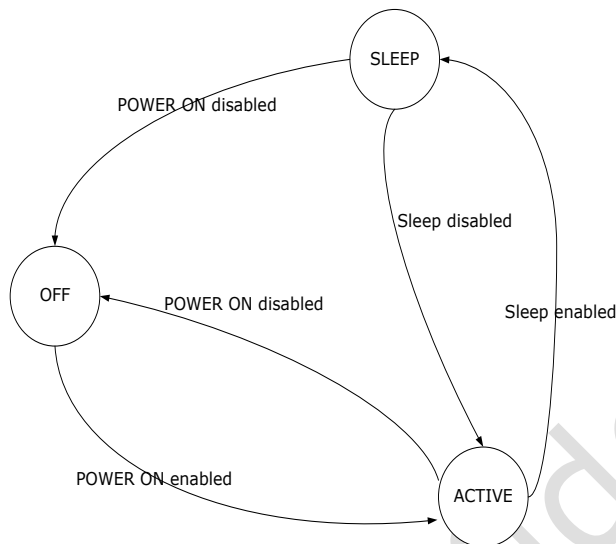

Fig. 4-1 State Machine

The RK817 state machine shown as above. The state shift by “power on”, “power down”, “reset”, “active to sleep” and “sleep to active”.

#### 4.1.2 Power on Description

There are three kinds of method to power on the PMIC.

##### 1. Press “PWRON” key

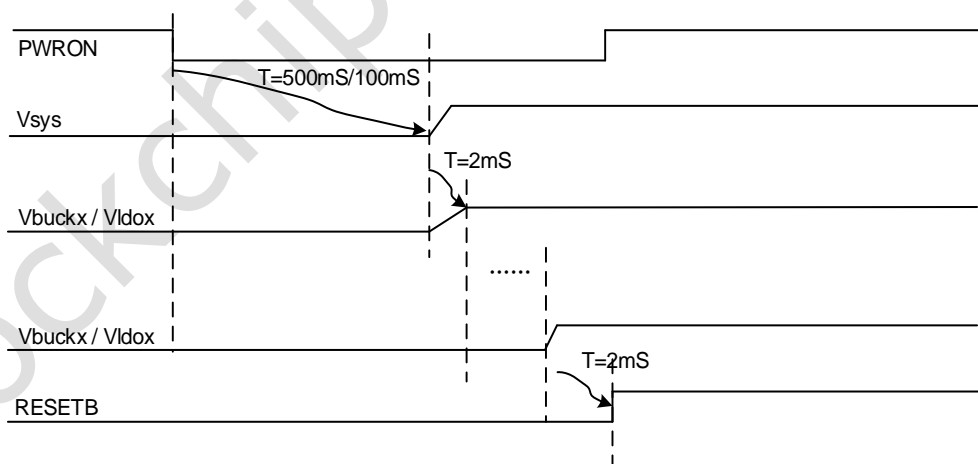

Fig. 4-2 Press “PWRON” key to turn on the PMIC

When the PMIC powered by a battery which voltage is higher than “VB\_OK” threshold, keeping low level at “PWRON” pin for 500/100mS would turn on the PMIC. The “PWRON” pin de-bounce time (500mS/100mS) can be adjusted by I2C.

All the power channels start up at the default output voltages with a preset power up sequence, which has 2mS intervals between the channels. When the power up process is done, the RESETB turns to high logic level to inform the processor that all the power rails are up and stable.

Note: If Register bit 0xE6<7> (SYS\_CAN\_SD) set to “0”, the SYS voltage would **NOT** be shut down, this is the only difference with the chart shown above.

**2. RTC Alarm**

When the PMIC powered by a battery which voltage is higher than "VB\_OK" threshold, Setting RTC alarm would turn on the PMIC. The power on sequence is the same with the first one.

For example, set RTC alarm registers: 0x07, 0x08, 0x09, 0x0A, 0x0B, 0x0C. And then set register 0x0F=2FH.

**3. USB Plug in**

When the PMIC powered by a battery, and then USB plug in that means VUSB is higher than 3.8V and VUSB is higher than VBAT for 100mS, the PMIC would be turn on. The power on sequence shown as below.

Note: If when USB keep attached, and then the PMIC is turn off, the PMIC would NOT turn on again. This is a function that charging in "OFF" state. Users must plug out the USB, and then plug in again to turn on the PMIC.

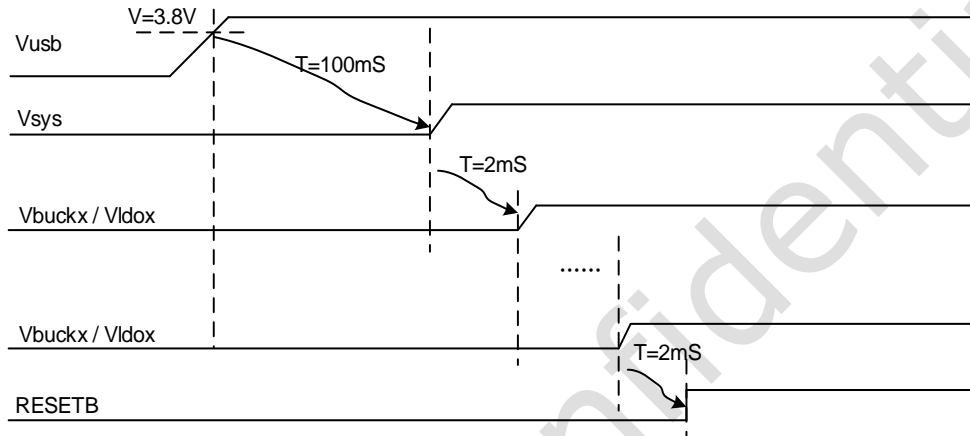

Fig. 4-3 USB plug in to turn on the PMIC

**4.1.3 Power down Description**

There are 7 kinds of method to power down the PMIC.

**1. Long press "PWRON" key**

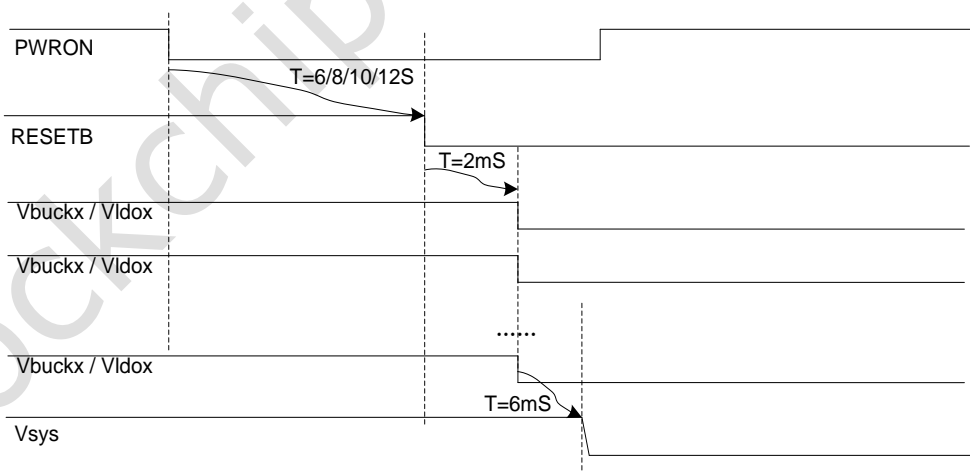

Fig. 4-4 Long press "PWRON" key to turn off the PMIC

When the PMIC work in the "ON" state or "SLEEP" state, Writing register bit 0xF7<6>="0", and then keeping low level at "PWRON" pin for 6/8/10/12S would turn off the PMIC. The "PWRON" pin de-bounce time (6/8/10/12S) can be adjusted by I2C.

When power down enable, The RESETB pin would be pulled low to reset the processor. And then 2ms later, the power channels start to be turned off at the same time.

**2. Write shutdown Register**

When the PMIC work in the "ON" state or "SLEEP" state, writing register bit 0xF4<0>="1" would turn off the PMIC. The power off sequence is the same with the first

one.

**3. SYS over-voltage**

When the PMIC work in the "ON" state or "SLEEP" state, if VSYS higher than 5.4V, the PMIC would be turn off. The power off sequence is the same with the first one.

**4. SYS under-voltage**

When the PMIC work in the "ON" state or "SLEEP" state, if VSYS lower than VB\_UV threshold (typical 2.7V) for 2mS, the PMIC would be turn off. For safe attention, the buck converter would be shut down immediately when detect VB\_UV.

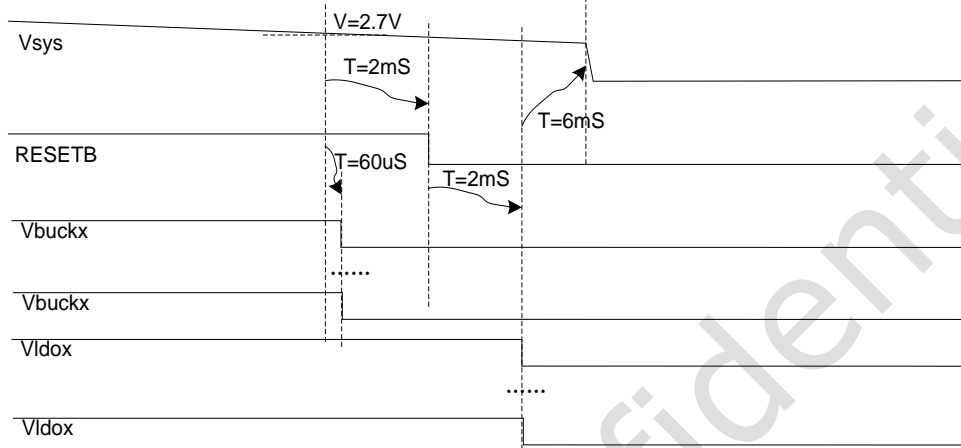

Fig. 4-5 VSYS under-voltage to turn off the PMIC

This would lead to processor system halted. So, Writing register bit 0xC6<5>="1" can fix this issue. The detail sequence will be found in "reset Description" chapter.

**5. SYS low-voltage**

When the PMIC work in the "ON" state or "SLEEP" state, if VSYS lower than VB\_LO threshold (typical 3.2V) for 2mS and Register bit 0XF1<3>="0", the PMIC would be turn off. The power off sequence is the same with the first one.

**6. SLEEP pin active**

When the PMIC work in the "ON" state or "SLEEP" state, if Register bit 0XF4<4:3>="10", and "SLEEP" pin active (the polarity can be programmed by Register bit 0XF4<5>), the PMIC would be turn off. The power off sequence is the same with the first one.

**7. TSD protection**

When the PMIC work in the "ON" state or "SLEEP" state, if the temperature is higher than TSD threshold (typical 160 degree), the PMIC would be turn off. The power off sequence is the same with the first one.

**4.1.4 Reset Description**

There are 4 kinds of method to reset the PMIC. If register bits 0xF4<7:6>="00", reset function means restart PMIC. If register bits 0xF4<7:6>="01", reset function means reset registers, all channels of power would be reset to default state.

**1. Long press "PWRON" key**

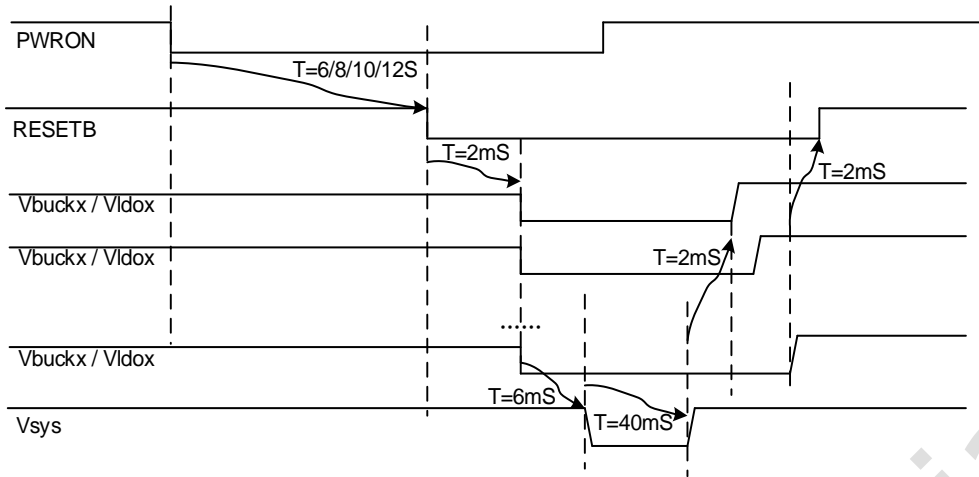

Fig. 4-6 Long press "PWRON" key to restart the PMIC

When the PMIC work in the "ON" state or "SLEEP" state, Writing register bit 0xF7<6>="1", and then keeping low level at "PWRON" pin for 6/8/10/12S would restart the PMIC. The "PWRON" pin de-bounce time (6/8/10/12S) can be adjusted by I2C.

Note: If the battery voltage is lower than VB\_OK threshold, the PMIC would be shut down but restart.

**2. SLEEP pin active**

When the PMIC work in the "ON" state or "SLEEP" state, if Register bit 0xF4<4:3>="11", and "SLEEP" pin active (the polarity can be programmed by Register bit 0xF4<5>), the PMIC would restart. The restart sequence is the same with the first one.

Note: If the battery voltage is lower than VB\_OK threshold, the PMIC would be shut down but restart.

**3. RESETB pin pull low**

When the PMIC work in the "ON" state or "SLEEP" state, if "RESETB" pin is pull down, the PMIC would restart immediately. The restart sequence is the same with the first one.

Note: If the battery voltage is lower than VB\_OK threshold, the PMIC would be shut down but restart.

**4. SYS under-voltage**

When the PMIC work in the "ON" state or "SLEEP" state, if VSYS lower than VB\_UV threshold (typical 2.7V) for 2mS, the PMIC would be turn off. But if register bit 0xC6<5>="1", the "RESET" pin would be pull down when VB\_UV happen. So, the PMIC would restart.

Note: If the battery voltage is lower than VB\_OK threshold, the PMIC would be shut down but restart.

**Note: Users must NOT set register bits 0xF4<7:6>="01" at this case.**

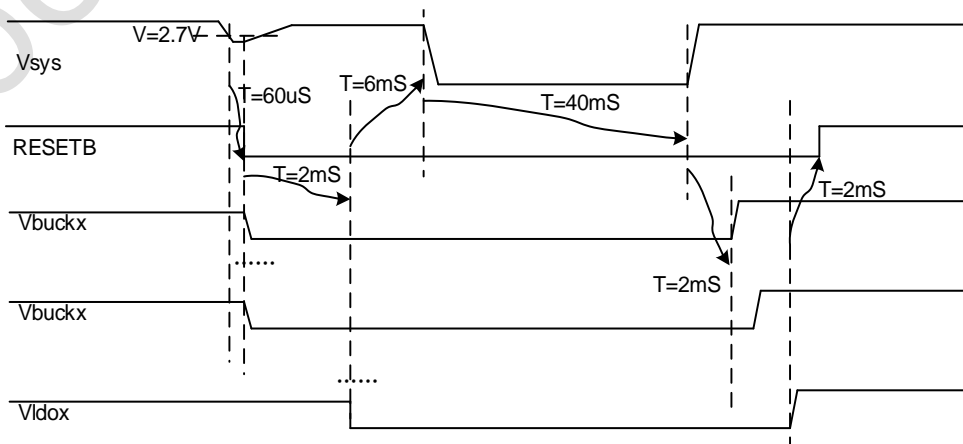

Fig. 4-7 VSYS under-voltage to restart the PMIC

### 4.1.5 Power Sequence Description

			RK817-1	
	Range of output voltage	Maximum output current	Default voltage	Start up sequence
BUCK1	0.5V-2.4V	2.5A	1.1V	1
BUCK2	0.5V-2.4V	2.5A	1.1V	1
BUCK3	X(external divided resistor) Or 0.5V-2.4v(internal divided resistor)	1.5A	x	3
BUCK4	0.5V-3.4V	1.5A	3.0V	4
BOOST	4.7V-5.4V	1.5A	5.0V	OFF
LDO1	0.6V-3.4V	400mA	1.0V	1
LDO2	0.6V-3.4V	400mA	1.8V	2
LDO3	0.6V-3.4V	100mA	1.0V	1
LDO4	0.6V-3.4V	400mA	3.0V	4
LDO5	0.6V-3.4V	400mA	3.0V	4
LDO6	0.6V-3.4V	400mA	3.0V	4
LDO7	0.6V-3.4V	400mA	0.6V	OFF
LDO8	0.6V-3.4V	400mA	0.6V	OFF
LDO9	0.6V-3.4V	400mA	0.6V	OFF
OTG	Equals to BOOST	1.5A	5.0V	OFF
VB_OK	2.8V-3.6V	x	3.0V	x

Table 4-1 RK817-1 Power up/down sequence(x:BUCK3 voltage determined by external divided resistor; LDO3 start up later than LDO1 for about 200uS) ,Short press PWRON key time is 500ms.

			RK817-2	
	Range of output voltage	Maximum output current	Default voltage	Start up sequence
BUCK1	0.5V-2.4V	2.5A	0.8V	1
BUCK2	0.5V-2.4V	2.5A	0.8V	1
BUCK3	X(external divided resistor) Or 0.5V-2.4v(internal divided resistor)	1.5A	x	3

			RK817-2	
	Range of output voltage	Maximum output current	Default voltage	Start up sequence
BUCK4	0.5V-3.4V	1.5A	3.3V	4
BOOST	4.7V-5.4V	1.5A	5.3V	OFF
LDO1	0.6V-3.4V	400mA	0.8V	1
LDO2	0.6V-3.4V	400mA	1.8V	2
LDO3	0.6V-3.4V	100mA	0.8V	1
LDO4	0.6V-3.4V	400mA	1.8V	2
LDO5	0.6V-3.4V	400mA	0.6V	OFF
LDO6	0.6V-3.4V	400mA	0.6V	OFF
LDO7	0.6V-3.4V	400mA	0.6V	OFF
LDO8	0.6V-3.4V	400mA	3.3V	4
LDO9	0.6V-3.4V	400mA	3.3V	4
OTG	Equals to BOOST	1.5A	5.3V	OFF
VB_OK	2.8V-3.6V	x	3.0V	x

Table 4-2 RK817-2 Power up/down sequence(x:BUCK3 voltage determined by external divided resistor; LDO3 start up later than LDO1 for about 200uS) ,Short press PWRON key time is 500ms.

			RK817-5	
	Range of output voltage	Maximum output current	Default voltage	Start up sequence
BUCK1	0.5V-2.4V	2.5A	0.9V	1
BUCK2	0.5V-2.4V	2.5A	0.9V	2
BUCK3	X(external divided resistor) Or 0.5V-2.4v(internal divided resistor)	1.5A	x	3
BUCK4	0.5V-3.4V	1.5A	3.3V	4
BOOST	4.7V-5.4V	1.5A	5.0V	OFF
LDO1	0.6V-3.4V	400mA	1.8V	2
LDO2	0.6V-3.4V	400mA	0.9V	1
LDO3	0.6V-3.4V	100mA	0.9V	1
LDO4	0.6V-3.4V	400mA	0.6V	OFF
LDO5	0.6V-3.4V	400mA	3.3V	4

			RK817-5	
	Range of output voltage	Maximum output current	Default voltage	Start up sequence
LDO6	0.6V-3.4V	400mA	3.3V	2
LDO7	0.6V-3.4V	400mA	1.8V	2
LDO8	0.6V-3.4V	400mA	0.6V	OFF
LDO9	0.6V-3.4V	400mA	0.6V	OFF
OTG	Equals to BOOST	1.5A	5.0V	OFF
VB_OK	2.8V-3.6V	x	3.4V	x

Table 4-3 RK817-5 Power up/down sequence(x:BUCK3 voltage determined by external divided resistor) ,Short press PWRON key time is 500ms.

#### 4.1.6 Sleep Description

The RK817 could be set to SLEEP mode by two kinds of way.

1. Register bits 0xF4<4:3>="01", and then Register bit 0xF4<1>="1".
2. Register bits 0xF4<4:3>="01", and then "SLEEP" pin active (the polarity can be programmed by Register bit 0XF4<5>)

When sleep mode, the power dissipation of RK817 would be decreased. Writing register bits 0xB9<4:0>="11111", 0xB9<7>="1", 0xF3<3>="1", 0xE3<7>="1" would be decrease quiescent current further.

## 4.2 Power Channels

### 4.2.1 Buck Description

The RK817 provides four high current synchronous buck converters, which deliver up to 3A, 3A, 1.5A and 1.5A, respectively. An enhanced COT architecture is used, which improves the transient response significantly. 2.5MHz switching frequency and good control method decrease the external inductance and capacitance. All output voltages can be adjusted dynamically during operation through DVS (Dynamic Voltage Scaling), which guarantees a linear and gradual voltage ramping up and down. A complete set of protection functions, such as short circuit protection, is implemented in the buck converters too.

For example, the BUCK1:  $V_{out}=1V$ ,  $V_{in}=4V$ ,  $L=0.47\mu H$ ,  $C_{out}=32\mu F$ . Load Current transient from 0.01A to 3A, the current slew rate is 3A/ $\mu s$  (using MOSFET transition). The output voltage drop when load current rising edge is about **38mV**, that is very good characteristics. The other bucks has the same architecture with BUCK1, so they have the same load transient response characteristics.

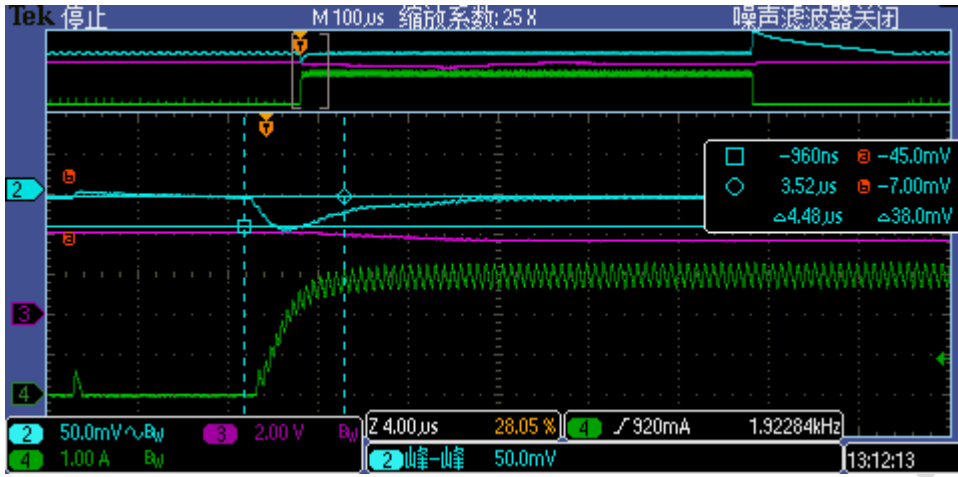

Fig. 4-8 BUCK1 load transient rising edge

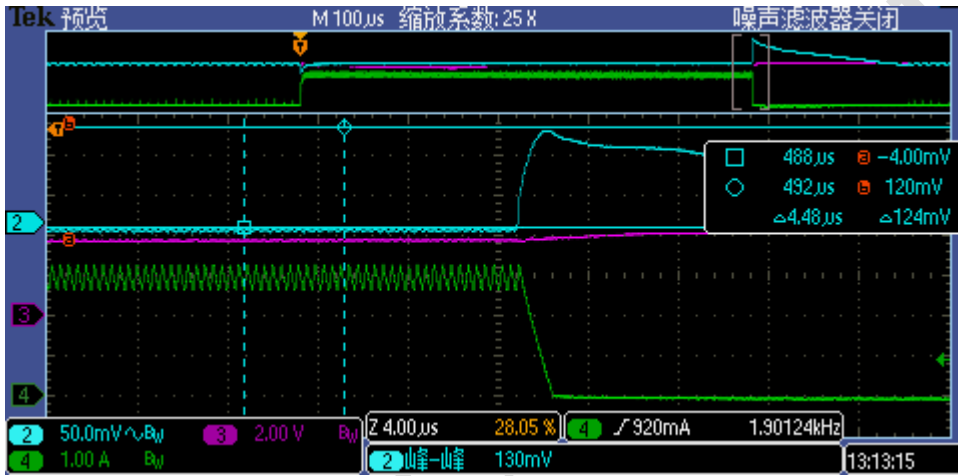

Fig. 4-9 BUCK1 load transient falling edge

If decreasing inductance to 0.33µH and increasing output capacitance to 44µF, the load transient response characteristics would be better.

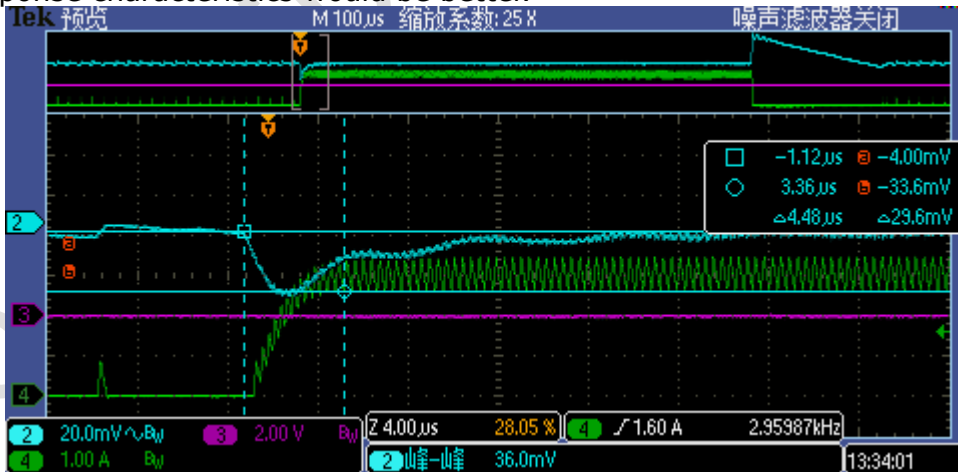

Fig. 4-10 BUCK1 load transient rising edge 2

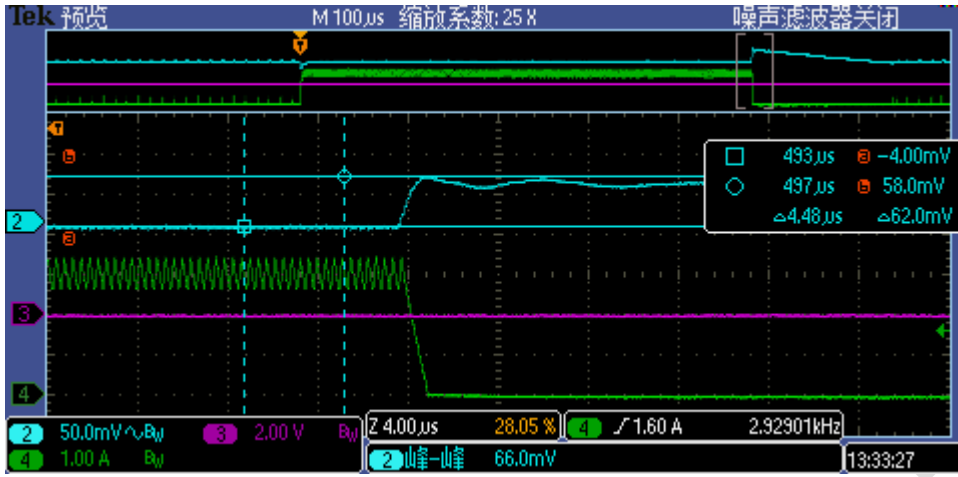

Fig. 4-11 BUCK1 load transient falling edge 2

Meanwhile, bucks converters have good efficiency characteristics. The test data shown as below. All channels of buck output voltage set to default.

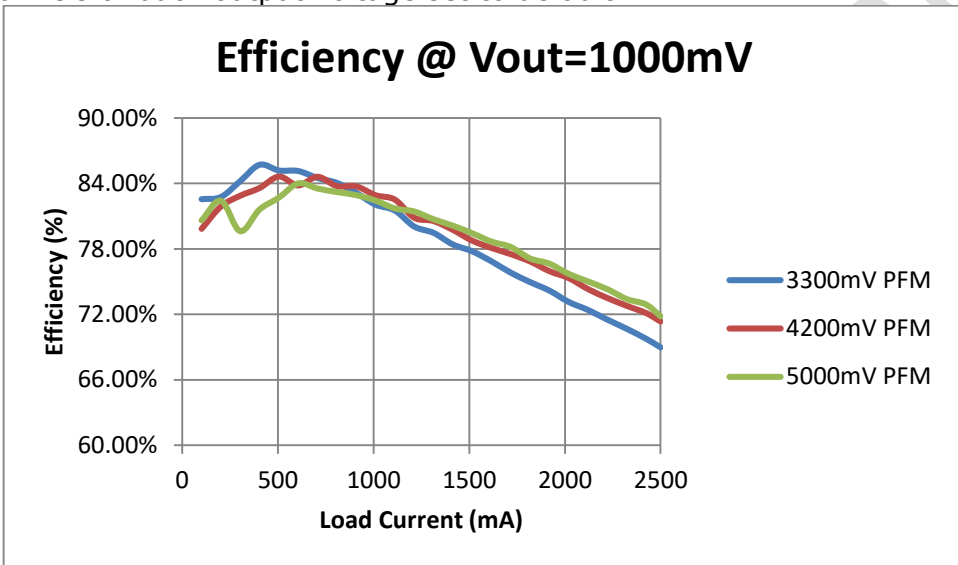

Fig. 4-12 BUCK1 efficiency curve when different input voltage

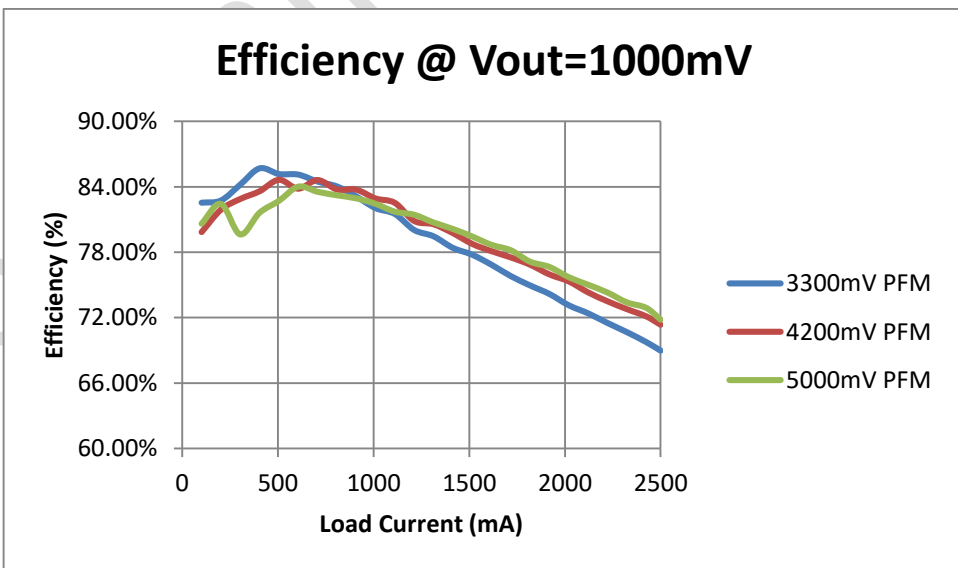

Fig. 4-13 BUCK2 efficiency curve when different input voltage

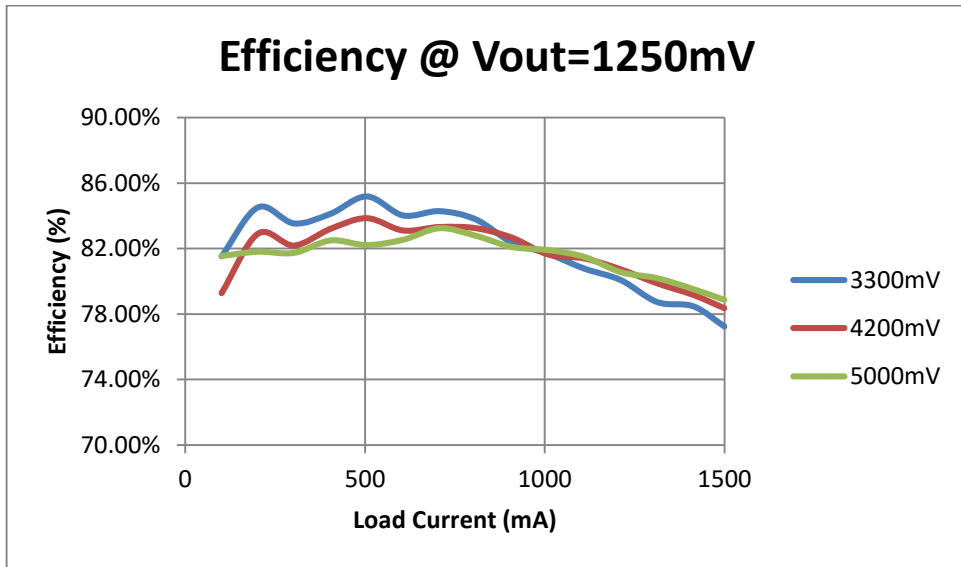

Fig. 4-14 BUCK3 efficiency curve when different input voltage

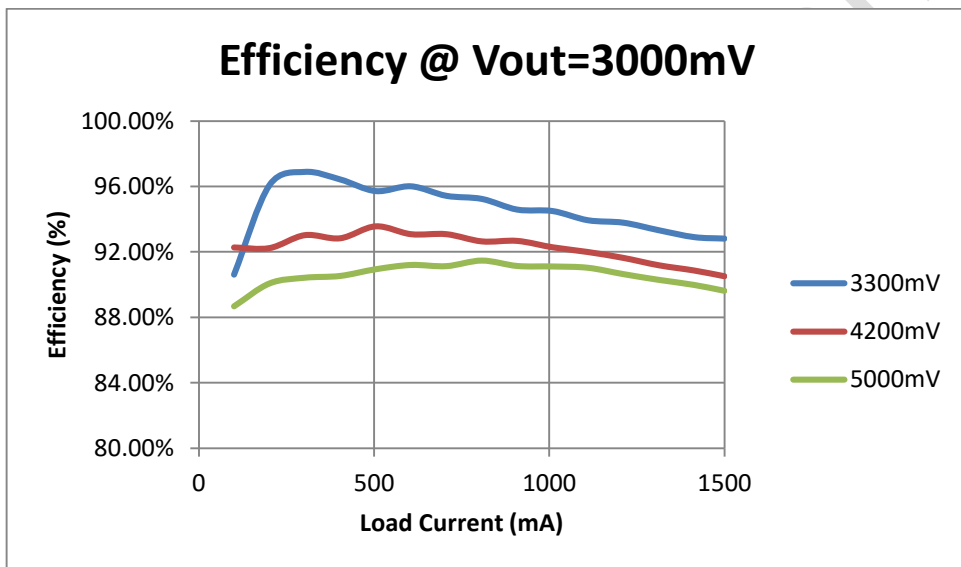

Fig. 4-15 BUCK4 efficiency curve when different input voltage

### 4.2.2 LDO Description

The RK817 also integrates nine LDOs, with 8 LDOs (LDO1, LDO2, LDO4~LDO9) capable of providing up to 400mA and one LDO3 providing maximum 100mA. The LDO3 is a low noise, high PSRR (75dB) LDO. All channels of LDO output capacitance could be 1.0uF that decreases the system cost. The parameters such as output voltage in the different operating modes can be adjusted through the I<sup>2</sup>C interface.

## 4.3 Switching Charger / Power Path / Boost / OTG

### 4.3.1 General Description

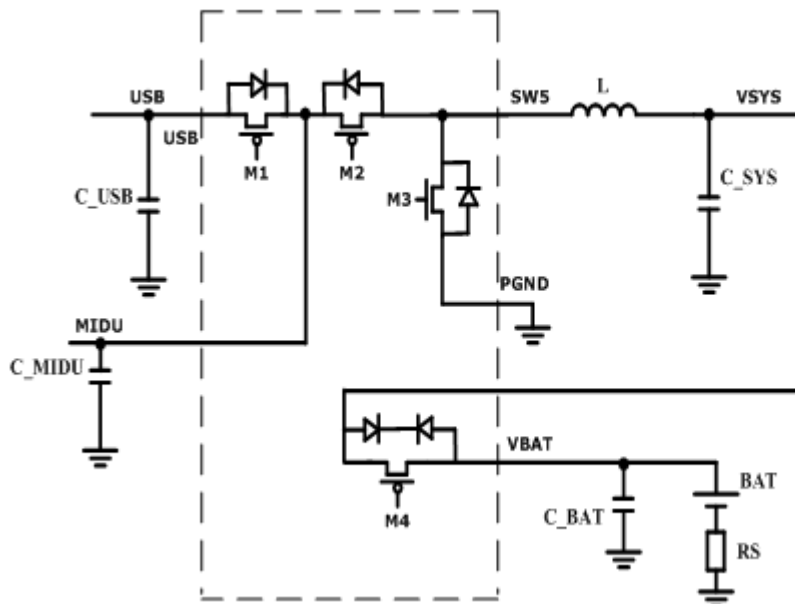

Fig. 4-16 Switching charger/ Power path/ Boost/ OTG architecture

The RK817 has integrated a switch mode Bi-direction charger, it could work as a charger from left to right, also work as boost and OTG from right to left. The PMOS M4 called power path MOS.

### 4.3.2 Charger Description

This charger which provides the functions like trickle current charging, constant current charging, constant voltage charging, charging termination, automatic recharging, battery temperature monitoring, charging timer and thermal feedback protection. The values of constant current and constant voltage charging can be set through I<sup>2</sup>C interface.

The input average current limit function allows as large as possible a charging current to be used without having to worry about the input current exceeding the maximum current allowed by the USB port. The input current limits can be configured through I<sup>2</sup>C interface. For example, when an USB port is used as the input, the input current limit can be configured to either 450mA, or 850mA, to meet the requirements of USB2.0 and USB3.0 respectively.

The charger also has a timer function which sets the maximum charging time for trickle, constant current and constant voltage charging, respectively. If the charging does not complete when a preset maximum charging time is reached, the charging is terminated.

The battery temperature can be monitored through the TS pin. A battery typically has a thermistor inside. The RK817 sinks a constant current into the thermistor and senses the voltage across the thermistor through an internal ADC. A safe charging temperature range is preset in the PMIC. The charging can proceed normally if the battery temperature falls within the preset range. If, however, the battery temperature goes either above the upper limit or below the lower limit of the preset range, the charging will pause until the battery temperature goes back in the preset range. If the value of the available thermistor is either too large or too small, a normal resistor can be connected in series or in parallel with the thermistor so that the sensed voltage fits the ADC's input range.

During Charging, VSYS will be set to 3.6V when the battery voltage is below 3.6V. This design is to guarantee that when an external power supply is plugged into the USB port to charge the battery while the battery voltage is low, the VSYS is already at 3.6V, which allows the PMIC to start up quickly without having to wait for the VSYS ramping up.

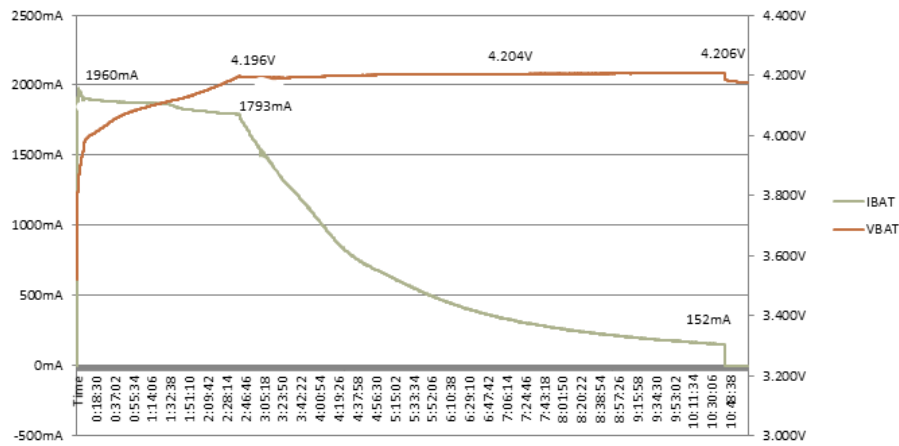

Fig. 4-17 Charge curve

### 4.3.3 Power Path Description

A power path management function is integrated in the RK817, which, together with the accurate input current limit function, can provide intelligent power path control. In a power path control process, the PMIC gives the outputs, or the system loads, the highest priority of using the input power. The battery is getting charged only if the input power is greater than the output power required by the system loads. The intelligent power path control function automatically reduces the charging current when the output power required by the loads increases. In an extreme case where the required output power is greater than the input power, the charging current will be cut off and the battery will join the input power supply to provide power to the load. This is how the intelligent power path control works: As the system power loading increases, the PMIC will draw more input current from the power supply to meet the output power requirement while keep the charging current unchanged. If the system power loading continues to increase to the point where the input current limit is reached, then the PMIC will lower the charging current so that enough power still goes to the load. If the system power loading further increases and due to the input current limit, the input power cannot meet the output power requirement, then the battery will start to discharge to supply power to the load together with the USB power supply. If for some reason the USB is unplugged, the battery will automatically switched in to take over the USB power supply and provide full power to the load. The wide power path loop bandwidth allows all the above mentioned power path switching transient to be quick and seamless and therefore no overshoot and notch occur at the VSYS.

To minimize the loss from the voltage drop along the current path when the battery is charged or discharged, a 100mΩ MOSFET is integrated in the RK817 to serve as a control switch as well as the power switch of the switching mode battery charger.

### 4.3.4 Boost /OTG Description

The synchronous boost converter has 1.5A current capability and is used to power the OTG. The OTG has a built-in current limiting switch, which can effectively protect the boost converter from being damaged if a short circuit occurs at the OTG port.

As the USB input port and the OTG output port share a same pin, when the USB port is being used as a power supply and charging the battery, the OTG switch is forbidden to be turned on. Only when there is no external power supply plugged into the USB port, can the OTG be turned on and serve as a power supply.

The key parameters such as operating mode, output voltage, and output current limit can be configured through the I<sup>2</sup>C interface.

## 4.4 Battery Gas Gauge

The RK817 provides an accurate battery fuel gauge. A 16-bits battery voltage ADC and a 16-bits battery current ADC are integrated in the RK817 to collect the information on the

battery, such as battery voltage, charging/discharging status, battery temperature, etc. Using the proprietary algorithms and the information collected by the ADC, the battery fuel gauge can accurately calculate the battery capacity based on the charging/discharging characteristics of the battery preloaded in the system. The gauge then sends the battery capacity information to the processor through the I<sup>2</sup>C interface.

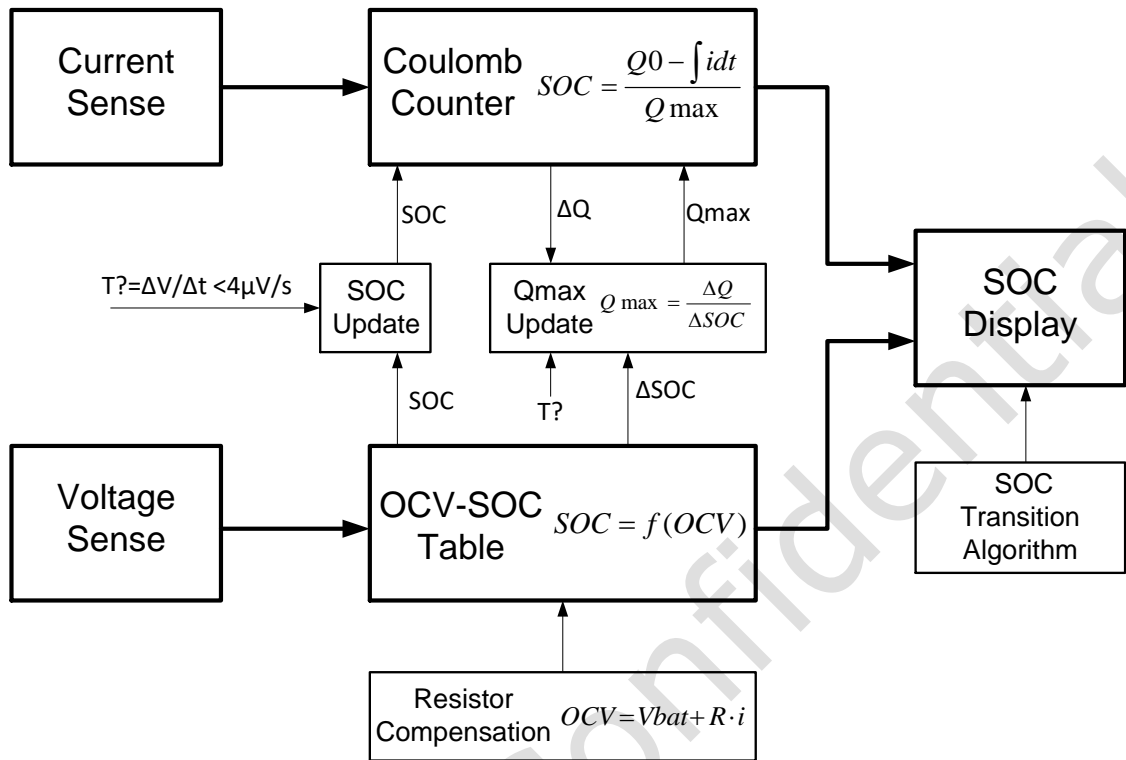

Fig. 4-18 Gas gauge architecture

The gas gauge accuracy determined by ADC accuracy, the ADC accuracy test data shown as below:

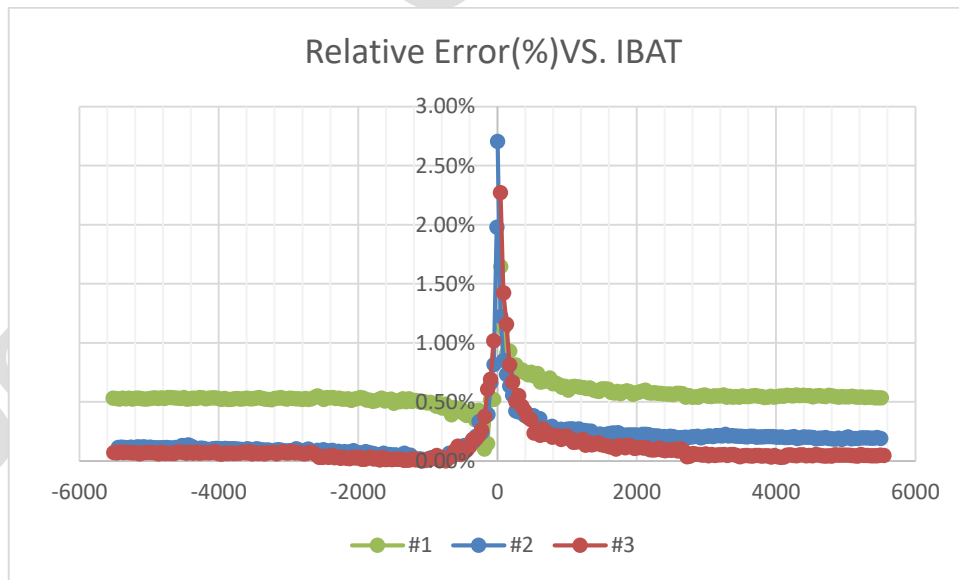

Fig. 4-19 Current ADC Relative Error Curve

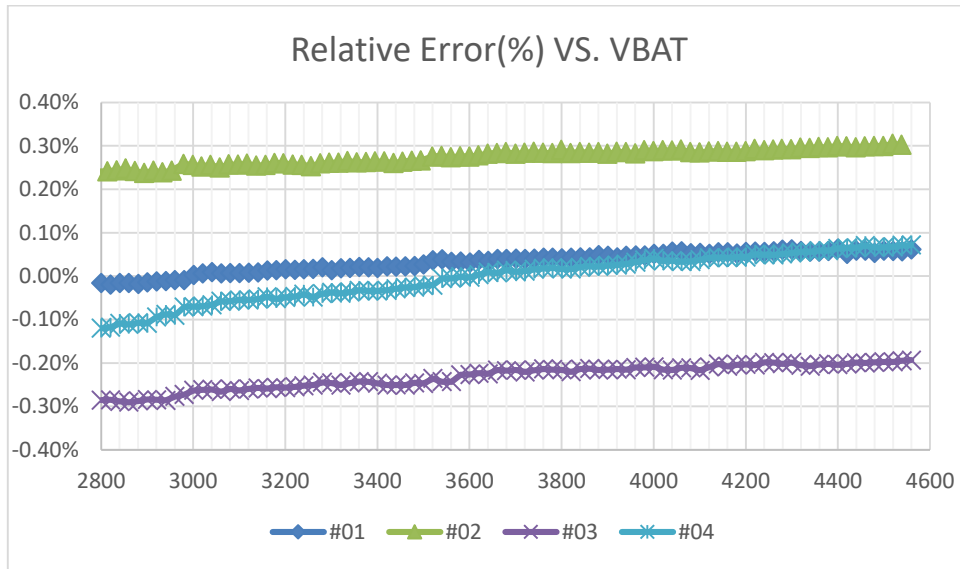

Fig. 4-20 Voltage ADC Relative Error Curve

## 4.5 Audio System

### 4.5.1 General Description

The RK817 integrates a high performance 24 bits ADC and a high performance 24 bits DAC. The audio recording path is composed of MIC\_PGA and audio ADC. DAC would convert digital signal to analog signal, and Class-AB driver adopt real-ground structure for Head-phone application, has very low THD (-90dB @1KHz@-3dBFS source). Meanwhile, Class-D driver integrated for speaker application. The speaker and head-phone can be used at the same time. I2S interface is integrated to communicate with processor.

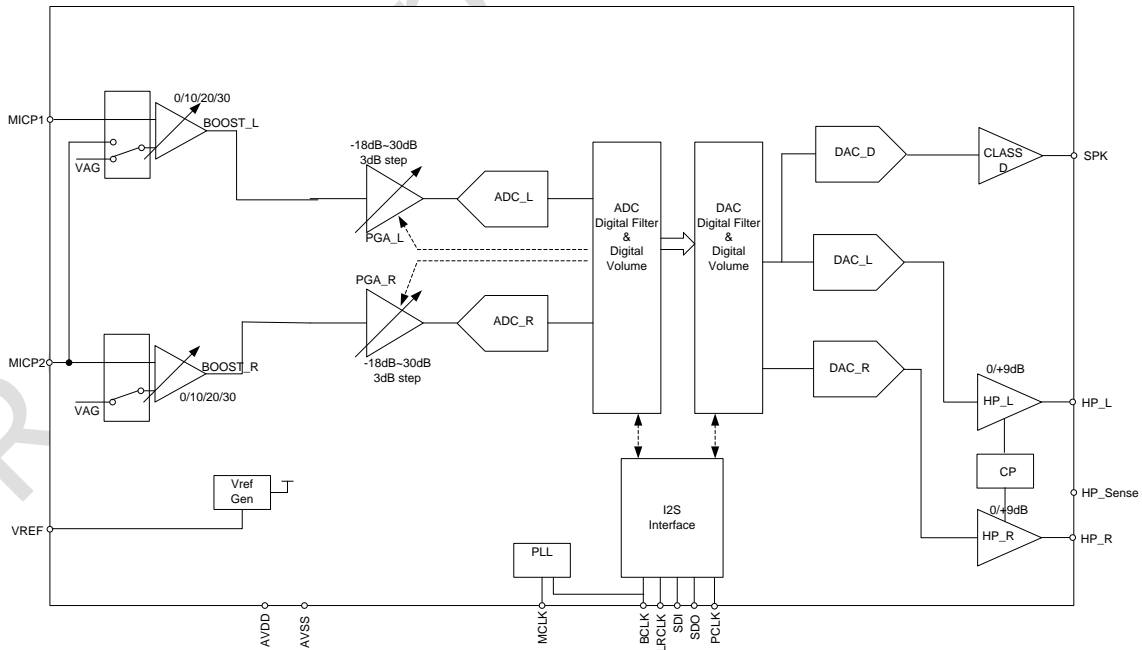

Fig. 4-21 Audio system architecture

## 4.5.2 Audio Recording Path Description

The RK817 integrate complete audio recording path solution. Users should set registers as below to configure audio recording path. For example, sample rate is 48K, MCLK=12.288MHz.

1. Enable I2S: 0x30=02H, 0x15=FFH.
2. Enable reference: 0x17=40H.
3. Setup PLL: 0x42=04H, 0x43=58H, 0x44=2DH, 0x45=0C, 0x46=A5H, 0x47=00H.
4. Setup sample rate: 0x1E=02H.
5. Setup I2S: 0x48=35H, 0x4D=00H, 0x4E=17H, 0x4F=80H.
6. Enable ADC: 0x15=F0H, 0x18=08H.
7. Enable Micro-phone: 0x27=80H (for differential mode MIC); Or 0x27=00H (for single end mode MIC).

The audio recording path THD+N ratio test data shown as below: typical case is -75dB.

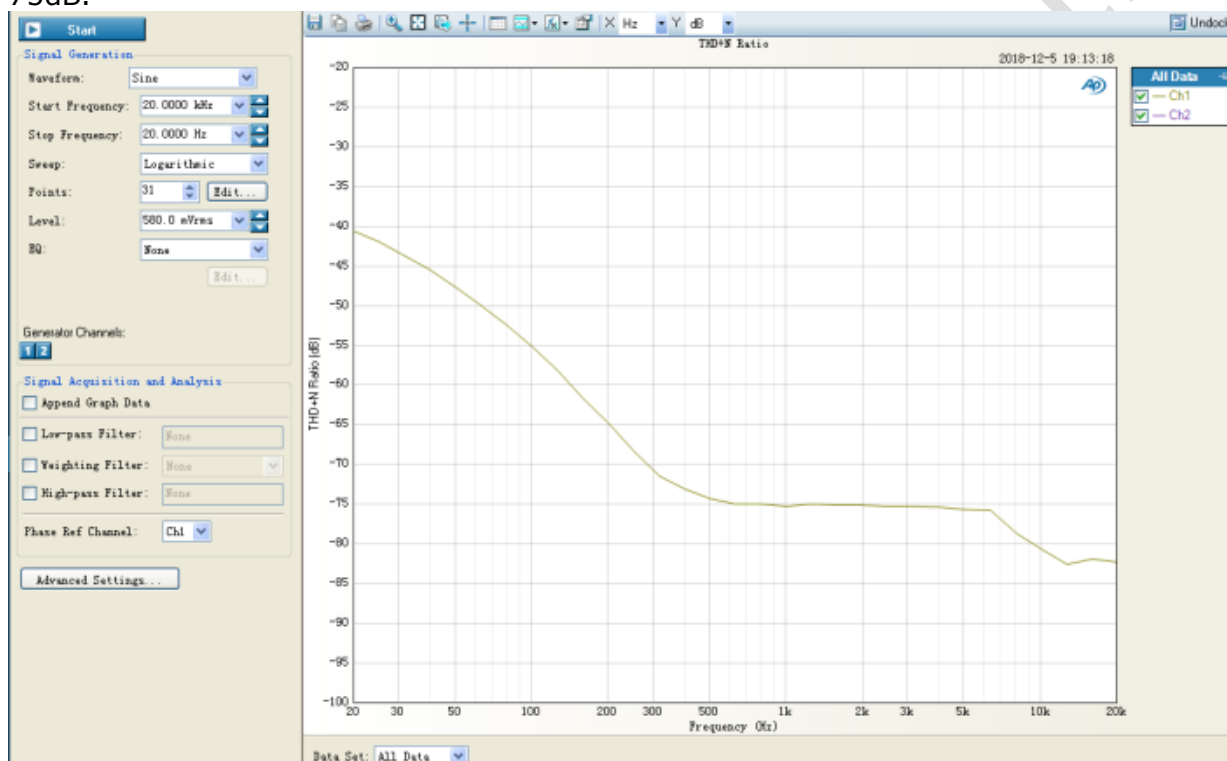

Fig. 4-22 Audio recording path THD+N ratio at differential mode

## 4.5.3 Head-Phone Path Description

The RK817 integrates a stereo output and with cap-free type headphone amplifier. It doesn't need to connect external capacitance, and can connect to earphone device directly.

Users should set registers as below to configure Head-phone path. For example, sample rate is 48K, MCLK=12.288MHz.

1. Enable I2S: 0x30=02H, 0x15=FFH.
2. Enable reference: 0x17=40H.
3. Setup PLL: 0x42=04H, 0x43=58H, 0x44=2DH, 0x45=0C, 0x46=A5H, 0x47=00H.
4. Setup sample rate: 0x35=02H.
5. Setup I2S: 0x48=00H, 0x49=00H, 0x4A=00H, 0x4B=17H, 0x4C=20H.
6. Enable DAC: 0x15=0FH, 0x2F=04H.
7. Enable Head-phone: 0x3F=11H, 0x3D=80H.

The Head-phone path THD+N ratio test data shown as below: typical case is -88dB.

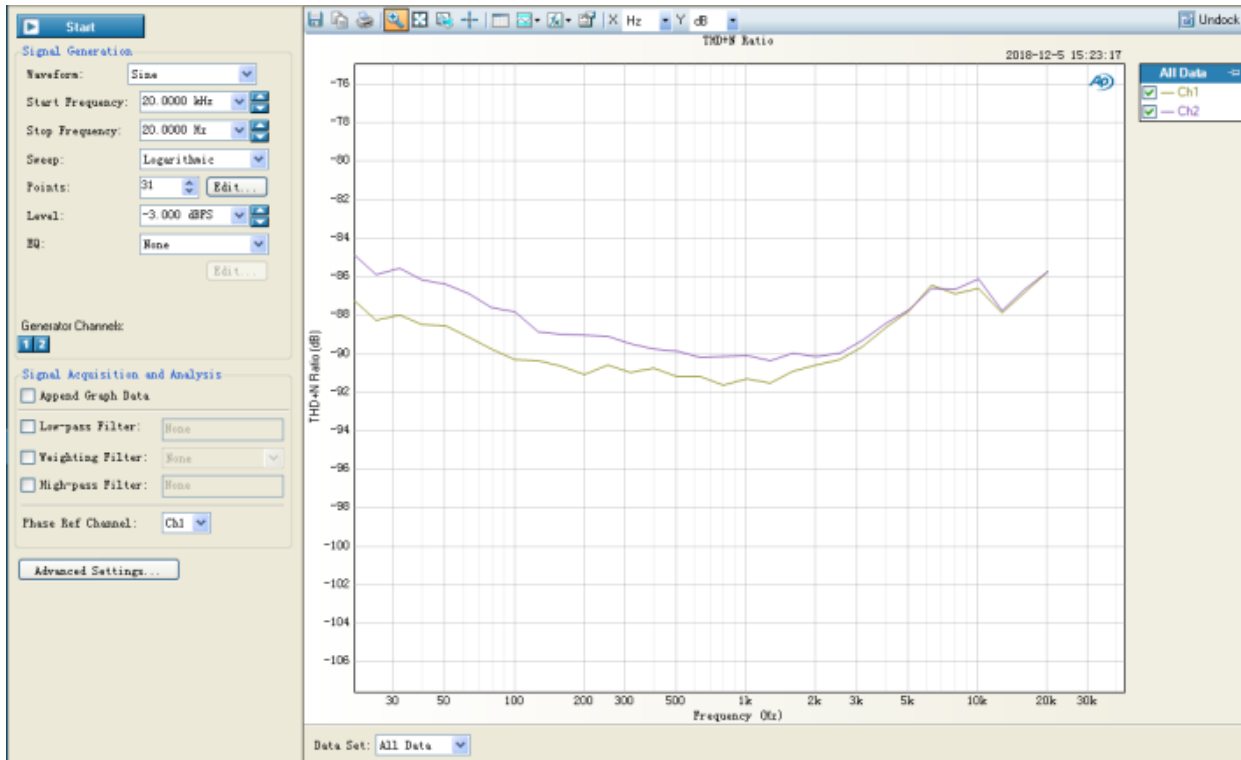

Fig. 4-23 Head-phone path THD+N ratio

#### 4.5.4 Speaker Path Description

The RK817 integrates a high efficiency stereo Class-D type amplifier capable of delivering 1.3W of power on an 8ohm BTL load from a 5V power supply. It integrates over-current protection.

Users should set registers as below to configure Speaker path. For example, sample rate is 48K, MCLK=12.288MHz.

1. Enable I2S: 0x30=02H, 0x15=FFH.
2. Enable reference: 0x17=40H.
3. Setup PLL: 0x42=04H, 0x43=58H, 0x44=2DH, 0x45=0C, 0x46=A5H, 0x47=00H.
4. Setup sample rate: 0x35=02H.
5. Setup I2S: 0x48=00H, 0x49=00H, 0x4A=00H, 0x4B=17H, 0x4C=20H.
6. Enable DAC: 0x15=0FH, 0x2F=03H.
7. Enable Class D: 0x38=10H, 0x40=A5H.

The Speaker path THD+N ratio test data shown as below: typical case is -62dB.

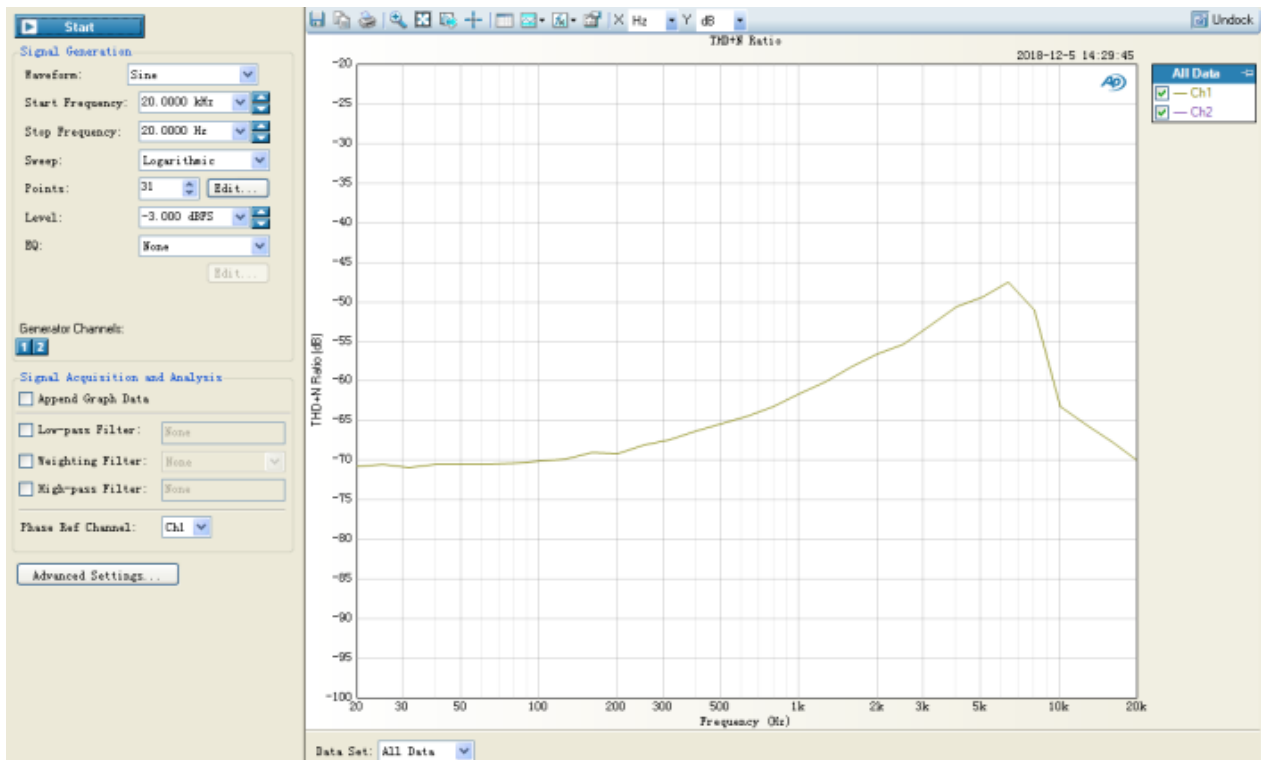

Fig. 4-24 Speaker path THD+N ratio

### 4.5.5 I2S Description

The RK817 supports I2S for the digital audio data interface. The I2S/PCM audio digital interface is used to input data to a stereo DAC or output data from a stereo ADC. The I2S/PCM audio interface can be configured to Master mode or Slave mode. In Master Mode, BCLK and LRCLK are configured as output, but MCLK is fixed as input. In Slave Mode, BCLK and LRCLK are configured as input, and the MCLK is still as input.

## 4.6 Others

### 4.6.1 Real Time Clock (RTC) Description

The RK817 integrates a crystal oscillator buffer and a real time clock (RTC). The buffer works with an external 32.768 kHz crystal oscillator. With the RTC function, the PMIC provides second/minute/hour/day/month/year information, alarm wake up as well as time calibration. The RK817 provides one channel of 32.768 kHz clocks with open drain outputs, where it is default on and is controlled through I<sup>2</sup>C interface.

### 4.6.2 RC Oscillator Description

The RK817 integrates an RC oscillator. If the external crystal oscillator is not connected, the chip will be driven by the internal RC oscillator. Without external crystal oscillator, the system costs can be saved, but the RTC and the fuel gauge will be inaccurate.

## Chapter 5 Register Description

### 5.1 Register Summary

Name	Offset	Size	Reset Value	Description
RTC_SECONDS	0x0000	B	0x00	
RTC_MINUTES	0x0001	B	0x00	
RTC_HOURS	0x0002	B	0x09	
RTC_DAYS	0x0003	B	0x04	
RTC_MONTHS	0x0004	B	0x08	
RTC_YEARS	0x0005	B	0x17	
RTC_WEEKS	0x0006	B	0x05	
RTC_ALARM_SECONDS	0x0007	B	0x00	
RTC_ALARM_MINUTES	0x0008	B	0x00	
RTC_ALARM_HOURS	0x0009	B	0x00	
RTC_ALARM_DAYS	0x000a	B	0x01	
RTC_ALARM_MONTHS	0x000b	B	0x01	
RTC_ALARM_YEARS	0x000c	B	0x00	
RTC_RTC_CTRL	0x000d	B	0x00	
RTC_RTC_STATUS	0x000e	B	0x82	
RTC_RTC_INT	0x000f	B	0x00	
RTC_RTC_COMP_LSB	0x0010	B	0x00	
RTC_RTC_COMP_MSB	0x0011	B	0x00	
CODEC_DTOP_VUCTL	0x0012	B	0x03	
CODEC_DTOP_VUETIME	0x0013	B	0x00	
CODEC_DTOP_LPT_SRST	0x0014	B	0x00	
CODEC_DTOP_DIGEN_CLKE	0x0015	B	0x00	
CODEC_AREF_RTCFG1	0x0017	B	0x06	
CODEC_AADC_CFG0	0x0018	B	0xc8	
CODEC_DADC_VOLL	0x001a	B	0x00	
CODEC_DADC_VOLR	0x001b	B	0x00	
CODEC_DADC_SR_ACL0	0x001e	B	0x00	
CODEC_DADC_ALC1	0x001f	B	0x00	
CODEC_DADC_ALC2	0x0020	B	0x00	
CODEC_DADC_NG	0x0021	B	0x00	
CODEC_DADC_HPF	0x0022	B	0x00	
CODEC_DADC_RVOLL	0x0023	B	0xff	
CODEC_DADC_RVOLR	0x0024	B	0xff	
CODEC_AMIC_CFG0	0x0027	B	0x70	
CODEC_AMIC_CFG1	0x0028	B	0x00	
CODEC_DMIC_PGA_GAIN	0x0029	B	0x66	
CODEC_DMIC_LMT1	0x002a	B	0x00	
CODEC_DMIC_LMT2	0x002b	B	0x00	
CODEC_DMIC_NG1	0x002c	B	0x00	

Name	Offset	Size	Reset Value	Description
CODEC_DMIC_NG2	0x002d	B	0x00	
CODEC_ADAC_CFG1	0x002f	B	0x07	
CODEC_DDAC_POPD_DACST	0x0030	B	0x82	
CODEC_DDAC_VOLL	0x0031	B	0x00	
CODEC_DDAC_VOLR	0x0032	B	0x00	
CODEC_DDAC_SR_LMT0	0x0035	B	0x00	
CODEC_DDAC_LMT1	0x0036	B	0x00	
CODEC_DDAC_LMT2	0x0037	B	0x00	
CODEC_DDAC_MUTE_MIXCTL	0x0038	B	0xa0	
CODEC_DDAC_RVOLL	0x0039	B	0xff	
CODEC_DDAC_RVOLR	0x003a	B	0xff	
CODEC_AHP_ANTI0	0x003b	B	0x00	
CODEC_AHP_ANTI1	0x003c	B	0x00	
CODEC_AHP_CFG0	0x003d	B	0xe0	
CODEC_AHP_CFG1	0x003e	B	0x1f	
CODEC_AHP_CP	0x003f	B	0x09	
CODEC_ACLASSD_CFG1	0x0040	B	0x69	
CODEC_ACLASSD_CFG2	0x0041	B	0x44	
CODEC_APLL_CFG0	0x0042	B	0x04	
CODEC_APLL_CFG1	0x0043	B	0x00	
CODEC_APLL_CFG2	0x0044	B	0x30	
CODEC_APLL_CFG3	0x0045	B	0x19	
CODEC_APLL_CFG4	0x0046	B	0x65	
CODEC_APLL_CFG5	0x0047	B	0x01	
CODEC_DI2S_CKM	0x0048	B	0x01	
CODEC_DI2S_RSD	0x0049	B	0x00	
CODEC_DI2S_RXCR1	0x004a	B	0x00	
CODEC_DI2S_RXCR2	0x004b	B	0x17	
CODEC_DI2S_RXCMD_TSD	0x004c	B	0x00	
CODEC_DI2S_TXCR1	0x004d	B	0x00	
CODEC_DI2S_TXCR2	0x004e	B	0x17	
CODEC_DI2S_TXCR3_TXCMD	0x004f	B	0x00	
gas_gauge_ADC_CONFIG0	0x0050	B	0x8c	
gas_gauge_ADC_CONFIG1	0x0055	B	0x30	
gas_gauge_GG_CON	0x0056	B	0x44	
gas_gauge_GG_STS	0x0057	B	0x00	
gas_gauge_RELAX_THRE_H	0x0058	B	0x00	
gas_gauge_RELAX_THRE_L	0x0059	B	0x60	
gas_gauge_RELAX_VOL1_H	0x005a	B	0x00	
gas_gauge_RELAX_VOL1_L	0x005b	B	0x00	
gas_gauge_RELAX_VOL2_H	0x005c	B	0x00	
gas_gauge_RELAX_VOL2_L	0x005d	B	0x00	
gas_gauge_RELAX_CUR1_H	0x005e	B	0x00	

Name	Offset	Size	Reset Value	Description
gas_gauge_RELAX_CUR1_L	0x005f	B	0x00	
gas_gauge_RELAX_CUR2_H	0x0060	B	0x00	
gas_gauge_RELAX_CUR2_L	0x0061	B	0x00	
gas_gauge_OCV_THRE_VOL	0x0062	B	0x00	
gas_gauge_OCV_VOL_H	0x0063	B	0x00	
gas_gauge_OCV_VOL_L	0x0064	B	0x00	
gas_gauge_OCV_VOL0_H	0x0065	B	0x00	
gas_gauge_OCV_VOL0_L	0x0066	B	0x00	
gas_gauge_OCV_CUR_H	0x0067	B	0x00	
gas_gauge_OCV_CUR_L	0x0068	B	0x00	
gas_gauge_OCV_CUR0_H	0x0069	B	0x00	
gas_gauge_OCV_CUR0_L	0x006a	B	0x00	
gas_gauge_PWRON_VOL_H	0x006b	B	0x00	
gas_gauge_PWRON_VOL_L	0x006c	B	0x00	
gas_gauge_PWRON_CUR_H	0x006d	B	0x00	
gas_gauge_PWRON_CUR_L	0x006e	B	0x00	
gas_gauge_OFF_CNT	0x006f	B	0x00	
gas_gauge_Q_INIT_H3	0x0070	B	0x00	
gas_gauge_Q_INIT_H2	0x0071	B	0x00	
gas_gauge_Q_INIT_L1	0x0072	B	0x00	
gas_gauge_Q_INIT_L0	0x0073	B	0x00	
gas_gauge_Q_PRES_H3	0x0074	B	0x00	
gas_gauge_Q_PRES_H2	0x0075	B	0x00	
gas_gauge_Q_PRES_L1	0x0076	B	0x00	
gas_gauge_Q_PRES_L0	0x0077	B	0x00	
gas_gauge_BAT_VOL_H	0x0078	B	0x00	
gas_gauge_BAT_VOL_L	0x0079	B	0x00	
gas_gauge_BAT_CUR_H	0x007a	B	0x00	
gas_gauge_BAT_CUR	0x007b	B	0x00	
gas_gauge_BAT_TS_H	0x007c	B	0x00	
gas_gauge_BAT_TS_L	0x007d	B	0x00	
gas_gauge_USB_VOL_H	0x007e	B	0x00	
gas_gauge_USB_VOL_L	0x007f	B	0x00	
gas_gauge_SYS_VOL_H	0x0080	B	0x00	
gas_gauge_SYS_VOL_L	0x0081	B	0x00	
gas_gauge_Q_MAX_H3	0x0082	B	0x00	
gas_gauge_Q_MAX_H2	0x0083	B	0x00	
gas_gauge_Q_MAX_L1	0x0084	B	0x00	
gas_gauge_Q_MAX_L0	0x0085	B	0x00	
gas_gauge_Q_TERM_H3	0x0086	B	0x00	
gas_gauge_Q_TERM_H2	0x0087	B	0x00	
gas_gauge_Q_TERM_L1	0x0088	B	0x00	
gas_gauge_Q_TERM_L0	0x0089	B	0x00	

Name	Offset	Size	Reset Value	Description
gas_gauge_Q_OCV_H3	0x008a	B	0x00	
gas_gauge_Q_OCV_H2	0x008b	B	0x00	
gas_gauge_Q_OCV_L1	0x008c	B	0x00	
gas_gauge_Q_OCV_L0	0x008d	B	0x00	
gas_gauge_OCV_CNT	0x008e	B	0x00	
gas_gauge_SLEEP_CON_SAMP_CUR_H	0x008f	B	0x00	
gas_gauge_SLEEP_CON_SAMP_CUR	0x0090	B	0x60	
gas_gauge_CAL_OFFSET_H	0x0091	B	0x7f	
gas_gauge_CAL_OFFSET_L	0x0092	B	0xff	
gas_gauge_VCALIB0_H	0x0093	B	0x00	
gas_gauge_VCALIB0_L	0x0094	B	0x00	
gas_gauge_VCALIB1_H	0x0095	B	0x00	
gas_gauge_VCALIB1_L	0x0096	B	0x00	
gas_gauge_IOFFSET_H	0x0097	B	0x00	
gas_gauge_IOFFSET_L	0x0098	B	0x00	
gas_gauge_BAT_R0	0x0099	B	0x00	
gas_gauge_BAT_R1	0x009a	B	0x00	
gas_gauge_BAT_R2	0x009b	B	0x00	
gas_gauge_BAT_R3	0x009c	B	0x00	
gas_gauge_DATA0	0x009d	B	0x00	
gas_gauge_DATA1	0x009e	B	0x00	
gas_gauge_DATA2	0x009f	B	0x00	
gas_gauge_DATA3	0x00a0	B	0x00	
gas_gauge_DATA4	0x00a1	B	0x00	
gas_gauge_DATA5	0x00a2	B	0x00	
gas_gauge_DATA6	0x00a3	B	0x00	
gas_gauge_DATA7	0x00a4	B	0x00	
gas_gauge_DATA8	0x00a5	B	0x00	
gas_gauge_DATA9	0x00a6	B	0x00	
gas_gauge_DATA10	0x00a7	B	0x00	
gas_gauge_DATA11	0x00a8	B	0x00	
gas_gauge_VOL_ADC_B3	0x00a9	B	0x00	
gas_gauge_VOL_ADC_B2	0x00aa	B	0x00	
gas_gauge_VOL_ADC_B1	0x00ab	B	0x00	
gas_gauge_VOL_ADC_B_7_0	0x00ac	B	0x00	
gas_gauge_CUR_ADC_K3	0x00ad	B	0x00	
gas_gauge_CUR_ADC_K2	0x00ae	B	0x00	
gas_gauge_CUR_ADC_K1	0x00af	B	0x00	
gas_gauge_CUR_ADC_K0	0x00b0	B	0x00	
PMIC_POWER_EN0	0x00b1	B	0x0f	
PMIC_POWER_EN1	0x00b2	B	0x0f	

Name	Offset	Size	Reset Value	Description
PMIC_POWER_EN2	0x00b3	B	0x06	
PMIC_POWER_EN3	0x00b4	B	0x00	
PMIC_POWER_SLP_EN0	0x00b5	B	0x0f	
PMIC_POWER_SLP_EN1	0x00b6	B	0x6f	
PMIC_POWER_DISCHRG_EN0	0x00b7	B	0xff	
PMIC_POWER_DISCHRG_EN1	0x00b8	B	0xff	
PMIC_POWER_CONFIG	0x00b9	B	0x00	
PMIC_BUCK1_CONFIG	0x00ba	B	0x64	
PMIC_BUCK1_ON_VSEL	0x00bb	B	0x28	
PMIC_BUCK1_SLP_VSEL	0x00bc	B	0x28	
PMIC_BUCK2_CONFIG	0x00bd	B	0x64	
PMIC_BUCK2_ON_VSEL	0x00be	B	0x28	
PMIC_BUCK2_SLP_VSEL	0x00bf	B	0x28	
PMIC_BUCK3_CONFIG	0x00c0	B	0x64	
PMIC_BUCK3_ON_VSEL	0x00c1	B	0x50	
PMIC_BUCK3_SLP_VSEL	0x00c2	B	0x50	
PMIC_BUCK4_CONFIG	0x00c3	B	0x64	
PMIC_BUCK4_ON_VSEL	0x00c4	B	0x62	
PMIC_BUCK4_SLP_VSEL	0x00c5	B	0x62	
PMIC_BUCK4_CMIN	0x00c6	B	0x04	
PMIC_LDO1_ON_VSEL	0x00cc	B	0x6c	
PMIC_LDO1_SLP_VSEL	0x00cd	B	0x6c	
PMIC_LDO2_ON_VSEL	0x00ce	B	0x10	
PMIC_LDO2_SLP_VSEL	0x00cf	B	0x10	
PMIC_LDO3_ON_VSEL	0x00d0	B	0x6c	
PMIC_LDO3_SLP_VSEL	0x00d1	B	0x6c	
PMIC_LDO4_ON_VSEL	0x00d2	B	0x10	
PMIC_LDO4_SLP_VSEL	0x00d3	B	0x10	
PMIC_LDO5_ON_VSEL	0x00d4	B	0x30	
PMIC_LDO5_SLP_VSEL	0x00d5	B	0x30	
PMIC_LDO6_ON_VSEL	0x00d6	B	0x30	
PMIC_LDO6_SLP_VSEL	0x00d7	B	0x30	
PMIC_LDO7_ON_VSEL	0x00d8	B	0x30	
PMIC_LDO7_SLP_VSEL	0x00d9	B	0x30	
PMIC_LDO8_ON_VSEL	0x00da	B	0x6c	
PMIC_LDO8_SLP_VSEL	0x00db	B	0x6c	
PMIC_LDO9_ON_VSEL	0x00dc	B	0x58	
PMIC_LDO9_SLP_VSEL	0x00dd	B	0x58	
PMIC_BOOST_OTG_CONFIG0	0x00de	B	0x0b	
PMIC_BOOST_CONFIG1	0x00df	B	0x33	
PMIC_CHRG_OUT	0x00e4	B	0xa2	
PMIC_CHRG_IN	0x00e5	B	0xc8	
PMIC_CHRG_TERM	0x00e6	B	0xc1	

Name	Offset	Size	Reset Value	Description
PMIC_CHRG_TERM_DIG	0x00e7	B	0x00	
PMIC_BAT_HTS_TS	0x00e8	B	0x00	
PMIC_BAT_LTS_TS	0x00e9	B	0xff	
PMIC_CHRG_TO	0x00ea	B	0x22	
PMIC_CHRG_STS	0x00eb	B	0x00	
PMIC_BAT_DISCHRG	0x00ec	B	0x0a	
PMIC_CHIP_NAME	0x00ed	B	0x81	
PMIC_CHIP_VER	0x00ee	B	0x72	
PMIC_OTP_VER	0x00ef	B	0x00	
PMIC_SYS_STS	0x00f0	B	0x00	
PMIC_SYS_CFG0	0x00f1	B	0x84	
PMIC_SYS_CFG1	0x00f2	B	0x80	
PMIC_SYS_CFG2	0x00f3	B	0x00	
PMIC_SYS_CFG3	0x00f4	B	0x20	
PMIC_ON_SOURCE	0x00f5	B	0x00	
PMIC_OFF_SOURCE	0x00f6	B	0x00	
PMIC_PWRON_KEY	0x00f7	B	0x06	
PMIC_INT_STS0	0x00f8	B	0x00	
PMIC_INT_MSK0	0x00f9	B	0x00	
PMIC_INT_STS1	0x00fa	B	0x00	
PMIC_INT_MSK1	0x00fb	B	0x00	
PMIC_INT_STS2	0x00fc	B	0x00	
PMIC_INT_MSK2	0x00fd	B	0x00	
PMIC_GPIO_INT_CONFIG	0x00fe	B	0x22	

Notes: Size: **B**- Byte (8 bits) access, **HW**- Half WORD (16 bits) access, **W**-WORD (32 bits) access

## 5.2 Register Description

### RTC\_SECONDS

Address: Operational Base + offset (0x0000)

Bit	Attr	Reset Value	Description
7	RW	0x0	RESV Reserved
6:4	RW	0x0	SEC1 Set the second digit of the RTC seconds (0-5)
3:0	RW	0x0	SEC0 Set the first digit of the RTC seconds (0-9)

### RTC\_MINUTES

Address: Operational Base + offset (0x0001)

Bit	Attr	Reset Value	Description
7	RW	0x0	RESV Reserved
6:4	RW	0x0	MIN1 Set the second digit of the RTC minutes (0-5)
3:0	RW	0x0	MIN0 Set the first digit of the RTC minutes (0-9)

**RTC\_HOURS**

Address: Operational Base + offset (0x0002)

Bit	Attr	Reset Value	Description
7	RW	0x0	AMPM Only used in PM-AM mode, 1: PM. 0:AM
6	RW	0x0	RESV Reserved
5:4	RW	0x0	HOUR1 Set the second digit of the RTC hours
3:0	RW	0x9	HOUR0 Set the first digit of the RTC hours

**RTC\_DAYS**

Address: Operational Base + offset (0x0003)

Bit	Attr	Reset Value	Description
7:6	RW	0x0	RESV Reserved
5:4	RW	0x0	DAY1 Set the second digit of the RTC days
3:0	RW	0x4	DAY0 Set the first digit of the RTC days

**RTC\_MONTHS**

Address: Operational Base + offset (0x0004)

Bit	Attr	Reset Value	Description
7:5	RW	0x0	RESV Reserved
4	RW	0x0	MONTH1 Set the second digit of the RTC months
3:0	RW	0x8	MONTH0 Set the first digit of the RTC months

**RTC\_YEARS**

Address: Operational Base + offset (0x0005)

Bit	Attr	Reset Value	Description
7:4	RW	0x1	YEAR1 Set the second digit of the RTC years
3:0	RW	0x7	YEAR0 Set the first digit of the RTC years

**RTC\_WEEKS**

Address: Operational Base + offset (0x0006)

Bit	Attr	Reset Value	Description
7:3	RW	0x00	RESV Reserved
2:0	RW	0x5	WEEK Set the second digit of the RTC weeks

**RTC\_ALARM\_SECONDS**

Address: Operational Base + offset (0x0007)

Bit	Attr	Reset Value	Description
7	RW	0x0	RESV Reserved
6:4	RW	0x0	ALARM_SEC1 Set the second digit of the RTC alarm seconds
3:0	RW	0x0	ALARM_SEC0 Set the first digit of the RTC alarm seconds

**RTC\_ALARM\_MINUTES**

Address: Operational Base + offset (0x0008)

Bit	Attr	Reset Value	Description
7	RW	0x0	RESV Reserved
6:4	RW	0x0	ALARM_MIN1 Set the second digit of the RTC alarm minutes
3:0	RW	0x0	ALARM_MIN0 Set the first digit of the RTC alarm minutes

**RTC\_ALARM\_HOURS**

Address: Operational Base + offset (0x0009)

Bit	Attr	Reset Value	Description
7	RW	0x0	ALARM_PM_AM Set alarm PM or AM: only used in PM-AM mode, 1: PM. 0:AM
6	RW	0x0	RESV Reserved
5:4	RW	0x0	ALARM_HOUR1 Set the second digit of the RTC alarm hours
3:0	RW	0x0	ALARM_HOUR0 Set the first digit of the RTC alarm hours

**RTC\_ALARM\_DAYS**

Address: Operational Base + offset (0x000a)

Bit	Attr	Reset Value	Description
7:6	RW	0x0	RESV Reserved
5:4	RW	0x0	ALARM_DAY1 Set the second digit of the RTC alarm days
3:0	RW	0x1	ALARM_DAY0 Set the first digit of the RTC alarm days

**RTC\_ALARM\_MONTHS**

Address: Operational Base + offset (0x000b)

Bit	Attr	Reset Value	Description
7:5	RW	0x0	RESV Reserved
4	RW	0x0	ALARM_MONTH1 Set the second digit of the RTC alarm months
3:0	RW	0x1	ALARM_MONTH0 Set the first digit of the RTC alarm months

**RTC\_ALARM\_YEARS**

Address: Operational Base + offset (0x000c)

Bit	Attr	Reset Value	Description
7:4	RW	0x0	ALARM_YEAR1 Set the second digit of the RTC alarm years
3:0	RW	0x0	ALARM_YEAR0 Set the first digit of the RTC alarm years

**RTC\_RTC\_CTRL**

Address: Operational Base + offset (0x000d)

Bit	Attr	Reset Value	Description
7	RW	0x0	RTC_READ_SEL 0: Read access directly to dynamic registers 1: Read access to static shadowed registers
6	RW	0x0	GET_TIME Rising transition of this register transferred dynamic registers into static shadowed registers.
5	RW	0x0	SET_32_COUNTER 1: set the 32-kHz counter with COMP_REG value. Note: It must only be used when the RTC is frozen.
4	RW	0x0	RESV Reserved
3	RW	0x0	AMPM_MODE 0: 24 hours mode. 1: 12 hours mode (PM-AM mode)
2	RW	0x0	AUTO_COMP 0: No auto compensation. 1: Auto compensation enabled
1	RW	0x0	ROUND_30S When "1" is written, the time is rounded to the closest minute in next second. Note: self cleared after rounding (Auto Clr)
0	RW	0x0	STOP_RTC 1: RTC is frozen 0: RTC is running. Note: RTC_time can only be changed during RTC frozen.

**RTC\_RTC\_STATUS**

Address: Operational Base + offset (0x000e)

Bit	Attr	Reset Value	Description
7	W1C	0x1	POWER_UP POWER_UP is set by a reset, is cleared by writing "1" in this bit.
6	W1C	0x0	ALARM Indicates that an alarm interrupt has been generated. Note: The alarm interrupt keeps its low level, until the micro-controller write "1" in the ALARM bit
5	W1C	0x0	EVENT_1D One day has occurred

Bit	Attr	Reset Value	Description
4	W1C	0x0	EVENT_1H One hour has occurred
3	W1C	0x0	EVENT_1M One minute has occurred
2	W1C	0x0	EVENT_1S One second has occurred
1	RO	0x1	RUN 0: RTC is frozen. 1: RTC is running. Note: This bit shows the real state of the RTC.
0	RW	0x0	RESV Reserved

**RTC\_RTC\_INT**

Address: Operational Base + offset (0x000f)

Bit	Attr	Reset Value	Description
7:6	RW	0x0	RESV Reserved
5	RW	0x0	ALARM_EN_PWRON enable the Alarm interrupt to trigger power on. 1: enable; 0: disable
4	RW	0x0	INT_SLEEP_MASK_EN 1: Mask periodic interrupt while the device is in SLEEP mode 0: Normal mode, no interrupt masked.
3	RW	0x0	INT_ALARM_EN Enable one interrupt when the alarm value is reached 1: Enable 0: Disable
2	RW	0x0	INT_TIMER_EN 1: Enable periodic interrupt; 0: disable periodic interrupt
1:0	RW	0x0	EVERY 00: every second; 01: every minute; 10: every hour; 11: every day

**RTC\_RTC\_COMP\_LSB**

Address: Operational Base + offset (0x0010)

Bit	Attr	Reset Value	Description
7:0	RW	0x00	RTC_COMP_LSB This register contains the number of 32-kHz periods to be added into the 32KHz counter every hour [LSB]

**RTC\_RTC\_COMP\_MSB**

Address: Operational Base + offset (0x0011)

Bit	Attr	Reset Value	Description
7:0	RW	0x00	RTC_COMP_MSB This register contains the number of 32-kHz periods to be added into the 32KHz counter every hour [MSB]

**CODEC\_DTOP\_VUCTL**

Address: Operational Base + offset (0x0012)

Bit	Attr	Reset Value	Description
7	RW	0x0	ADC_BYPS ADC volume control bypass 0:ADC volume control enable 1: ADC volume control bypass
6	RW	0x0	DAC_BYPS 0:DAC volume control enable 1:DAC volume control bypass
5	RW	0x0	ADCFade ADC Fade: ADC volume adjust mode 0:update to new volume immediately; 1:update volume as ADCZDT field describes;
4	RW	0x0	DACFade DAC Fade: DAC volume adjust mode 0:update to new volume immediately; 1:update volume as DACZDT field describes;
3:2	RW	0x0	RESV Reserved
1	RW	0x1	ADCZDT ADC cross zero detect enable. It works when ADC_BYPS is 0 and ADC_FADE is 1. 0:volume adjusts every sample 1:volume adjusts only when audio waveform crosses zero or volume-control time-limit condition meets; Note: All codec register reset by 'RST'or power down.

Bit	Attr	Reset Value	Description
0	RW	0x1	<p>DACZDT                      DAC cross zero detect enable. It works when DAC_BYPS is 0 and DAC_FADE is 1.                      0:volume adjusts every sample                      1:volume adjusts only when audio waveform crosses zero or volume-control time-limit condition meets;                      Note: All codec register reset by 'RST'or power down.</p>

**CODEC\_DTOP\_VUCTIONE**

Address: Operational Base + offset (0x0013)

Bit	Attr	Reset Value	Description
7:0	RW	0x00	<p>VUCT                      VUCT: volume control time limit, valid only in fade cross zero mode                      Time limit = VUCT *(1/sample rate)                      Unit: LRCLK</p>

**CODEC\_DTOP\_LPT\_SRST**

Address: Operational Base + offset (0x0014)

Bit	Attr	Reset Value	Description
7	RW	0x0	<p>RESV                      Reserved</p>
6	RW	0x0	<p>SRST                      soft reset, write 1 to reset                      read 1: resetting 0: not resetting</p>
5	RW	0x0	<p>LP_DET                      LP_DET: low power detected, valid when DAC automatically power-on and power-down enabled                      0:not detected;                      1:low power detected;</p>
4:0	RW	0x00	<p>LPT                      LPT: low power detect                      threshold:power(2,LPT)</p>

**CODEC\_DTOP\_DIGEN\_CLKE**

Address: Operational Base + offset (0x0015)

Bit	Attr	Reset Value	Description
7	RW	0x0	ADC_CKE ADC clock enable 1:enable; 0:disable;
6	RW	0x0	I2STX_CKE I2S Tx channel clock enable 1:enable; 0:disable;
5	RW	0x0	ADC_EN Digital adc channel enable 1:enable; 0:disable;
4	RW	0x0	I2STX_EN I2S Tx channel enable 1:enable; 0:disable;
3	RW	0x0	DAC_CKE DAC clock enable 1:enable; 0:disable;
2	RW	0x0	I2SRX_CKE I2S Rx channel clock enable 1:enable; 0:disable;
1	RW	0x0	DAC_EN Digital dac channel enable 1:enable; 0:disable;
0	RW	0x0	I2SRX_EN I2S Rx channel enable 1:enable; 0:disable;

**CODEC\_AREF\_RTCFG1**

Address: Operational Base + offset (0x0017)

Bit	Attr	Reset Value	Description
7	RW	0x0	Internal used, don't over write.
6	RW	0x0	LDO1P8A_EN_CODEC Enable the LDO 1P8A, default don't setup. For sleep used only. 0:not effect 1:enable
5	RW	0x0	REF_ADC_SEL Select the ADC reference voltage 0: 1.2V 1: 1.5V
4:3	RW	0x0	VAG_SEL Select the VAG voltage 00:0.9V 01:0.72V 10:1.08V 11:1.26V
2	RW	0x1	PWD_IBIAS Power down the ibias block in REF_TOP 0:IBIAS block power on 1:IBIAS block power down

Bit	Attr	Reset Value	Description
1	RW	0x1	PWD_VAG_BUF Power down the Vag buffer in REF_TOP 0:Vag buffer block power on 1:Vag buffer block power down
0	RW	0x0	RESV Reserved

**CODEC\_AADC\_CFG0**

Address: Operational Base + offset (0x0018)

Bit	Attr	Reset Value	Description
7	RW	0x1	ADC_L_PWD Power down ADC left channel 0: ADC left channel power on 1: ADC left channel power down
6	RW	0x1	ADC_R_PWD Power down ADC right channel 0: ADC right channel power on 1: ADC right channel power down
5	RW	0x0	ADC_CLK_EDGE_SEL Select the ADC output data and clock edge relationship 0: using the ADC falling edge to send the ADC data 1: using the ADC rising edge to send the ADC data
4	RW	0x0	RESV Reserved
3	RW	0x1	ADC_DITH_OFF Disable the dither function of ADC 0: enable the ADC dither 1:disable the ADC dither
2:0	RW	0x0	ADC_DITH_SEL Select the dither frequency of ADC 000: 1/50 of ADC clock 001: 1/33 of ADC clock 010: 1/20 of ADC clock 011: 1/15 of ADC clock 100: 1/10 of ADC clock 101: 1/8 of ADC clock 110: 1/6 of ADC clock 111: 1/4 of ADC clock

**CODEC\_DADC\_VOLL**

Address: Operational Base + offset (0x001a)

Bit	Attr	Reset Value	Description
7:0	RW	0x00	ADCLV ADC path L-channel Digital Volume Register 0db~-95db, 0.375db/step 8'h0: 0db 8'h1:-0.375db 8'h2:-0.75db 8'h3:-1.125db ... 8'hff:-95db

**CODEC\_DADC\_VOLR**

Address: Operational Base + offset (0x001b)

Bit	Attr	Reset Value	Description
7:0	RW	0x00	ADCRV ADC path R-channel Digital Volume Register 0db~-95db, 0.375db/step 8'h0: 0db 8'h1:-0.375db 8'h2:-0.75db 8'h3:-1.125db ... 8'hff:-95db

**CODEC\_DADC\_SR\_ACL0**

Address: Operational Base + offset (0x001e)

Bit	Attr	Reset Value	Description
7	RW	0x0	ALCL ALC L-channel enable: automatic level control enable for ADC left channel 0: disable 1:enable
6	RW	0x0	ALCR ALC R-channel enable: automatic level control enable for ADC right channel 0: disable 1:enable
5	RW	0x0	ADC_LV_POL ADC path L-channel Digital Volume polarity 0:negative gain; 1:postive gain
4	RW	0x0	ADC_RV_POL ADC path R-channel Digital Volume polarity 0:negative gain; 1:postive gain
3	RW	0x0	RESV Reserved

Bit	Attr	Reset Value	Description
2:0	RW	0x0	ADCSRT ADC sample rate times: sample rate = 8k/11.025k/12k * power(2,ADCSRT) note that sample rate base(8K/11.025K/12K) is decided by PLL configuration.

**CODEC\_DADC\_ALC1**

Address: Operational Base + offset (0x001f)

Bit	Attr	Reset Value	Description
7:4	RW	0x0	ALCARATE ALC attack rate =sample rate/( 8*power(2,ALCARATE))
3:0	RW	0x0	ALCRRATE ALC Release rate=sample rate/( 8*power(2,ALCRRATE))

**CODEC\_DADC\_ALC2**

Address: Operational Base + offset (0x0020)

Bit	Attr	Reset Value	Description
7	RO	0x0	NGVALID: noise gate valid status 0:not in NG status;1: now in NG status;
6:4	RW	0x0	ALCMAX The highest threshold of ALC; 000~100:0db~-12db,3db/step; 101~111:-18db~-30db,6db/step;
3	RW	0x0	RESV Reserved
2:0	RW	0x0	ALCMIN The lowest threshold of ALC; 000~100:0db~-12db,3db/step; 101~111:-18db~-30db,6db/step;

**CODEC\_DADC\_NG**

Address: Operational Base + offset (0x0021)

Bit	Attr	Reset Value	Description
7	RW	0x0	NGCHL: noise gate channel 0,individual channel(or); 1,both channel(and);

Bit	Attr	Reset Value	Description
6	RW	0x0	NGEN: noise gate enable 0,Noise gate Disable; 1,Noise gate enable;
5	RW	0x0	NGBOOST: noise gate boost 0,Normal noise gate; 1,Boost noise gate;
4:2	RW	0x0	NGGATE: noise gate threshold NGBOOST = 0: 000~111(-63~-84,3db/step) NGBOOST = 1: 000~111(-33~-54,3db/step)
1:0	RW	0x0	NGDLY: noise gate delay The delay time before the noise gate attacks 00~11:2048~4096~8192~16384 samples

**CODEC\_DADC\_HPF**

Address: Operational Base + offset (0x0022)

Bit	Attr	Reset Value	Description
7	RW	0x0	HPFL: high pass filter enable for left channel 0:high pass filter for left channel is disabled 1: high pass filter for left channel is enabled
6	RW	0x0	HPFR: high pass filter enable for right channel 0:high pass filter for right channel is disabled 1: high pass filter for right channel is enabled
5:4	RW	0x0	HPF_CF: high pass filter configure register 00:3.79Hz; 01:60Hz; 02:243Hz; 03:493Hz
3:0	RW	0x0	RESV Reserved

**CODEC\_DADC\_RVOLL**

Address: Operational Base + offset (0x0023)

Bit	Attr	Reset Value	Description
7:0	RO	0xff	ADCRLV ADC internal gain of left ch

**CODEC\_DADC\_RVOLR**

Address: Operational Base + offset (0x0024)

Bit	Attr	Reset Value	Description
7:0	RO	0xff	ADCRRV ADC internal gain of right ch

**CODEC\_AMIC\_CFG0**

Address: Operational Base + offset (0x0027)

Bit	Attr	Reset Value	Description
7	RW	0x0	MIC_DIFF_EN Enable differential mic mode 0:disable 1:enable
6	RW	0x1	PWD_MIC MIC Power Down 0: MIC block power on 1: MIC block power down
5	RW	0x1	PWD_PGA_L PGA_L Power Down 0:PGA_L block power on 1:PGA_L block power down
4	RW	0x1	PWD_PGA_R PGA_R Power Down 0:PGA_R block power on 1:PGA_R block power down
3:2	RW	0x0	MIC_L_BOOST Select the gain of left mic input signal 00:0dB, 01:10dB 10:20dB 11:30dB
1:0	RW	0x0	MIC_R_BOOST Select the gain of right mic input signal 00:0dB, 01:10dB 10:20dB 11:30dB

**CODEC\_AMIC\_CFG1**

Address: Operational Base + offset (0x0028)

Bit	Attr	Reset Value	Description
7	RW	0x0	PGA_L_IN_SEL PGA L-channel input select 0: Positive end of Mic amplifier output 1:internal reference voltage
6	RW	0x0	PGA_R_IN_SEL PGA R-channel input select 0: Negative end of Mic amplifier output 1:internal reference voltage
5	RW	0x0	MIC_CHOP_EN Enable the chopping function of MIC 0:disable 1:enable
4	RW	0x0	PGA_CHOP_EN Enable the chopping function of PGA 0:disable 1:enable
3:2	RW	0x0	MIC_CHOP_SEL 00:200k, 01:400k, 10:800k, 11:Reserved
1:0	RW	0x0	PGA_CHOP_SEL 00:200k, 01:400k, 10:800k, 11:Reserved

**CODEC\_DMIC\_PGA\_GAIN**

Address: Operational Base + offset (0x0029)

Bit	Attr	Reset Value	Description
7:4	RW	0x6	PGA_L_GAIN Change the gain of PGA block, the value changed from -18dB to 27dB. 0000:-18db; 1111:27db, 3db/step
3:0	RW	0x6	PGA_R_GAIN Change the gain of PGA block, the value changed from -18dB to 27dB. 0000: -18db; 1111:27db, 3db/step

**CODEC\_DMIC\_LMT1**

Address: Operational Base + offset (0x002a)

Bit	Attr	Reset Value	Description
7	RW	0x0	PGA_LMT_EN PGA gain limiter enable 0:disable 1:enable
6:4	RW	0x0	MAX_PGA_LMT The highest threshold of LIMITER; 000~100:0db~-12db,3db/step; 101~111:-18db~-30db,6db/step;
3	RW	0x0	RESV Reserved
2:0	RW	0x0	MIN_PGA_LMT The lowest threshold of LIMITER

**CODEC\_DMIC\_LMT2**

Address: Operational Base + offset (0x002b)

Bit	Attr	Reset Value	Description
7:4	RW	0x0	ATK_RATE_PGA_LMT LIMITER Attack $rate=(power(2,ATK\_RATE\_PGA\_LMT)*(8*clk1x))$ Clk1x is such as 4.096Mhz,5.6448Mhz,6.144Mhz
3:0	RW	0x0	RLS_RATE_PGA_LMT LIMITER Release $rate=(power(2,RLS\_RATE\_PGA\_LMT)*(8*clk1x))$ Clk1x is such as 4.096Mhz,5.6448Mhz,6.144Mhz

**CODEC\_DMIC\_NG1**

Address: Operational Base + offset (0x002c)

Bit	Attr	Reset Value	Description
7	RW	0x0	NGCHL_LI 0:individual channel; 1:both channel;
6	RW	0x0	NGEN_LI 0:Noise gate Disable; 1:Noise gate enable;
5	RW	0x0	NGBOOST_LI 0:Normal noise gate; 1: Boost noise gate;
4:2	RW	0x0	NGGATE_LI NGBOOST_LI = 0: 000~111(-63~-84,3db/step) NGBOOST_LI = 1: 000~111(-33~-54,3db/step)
1:0	RW	0x0	NGDLY_LI The delay time before the noise gate attacks 00~11:2048~4096~8192~16384, unit: (clk1x * 8)

**CODEC\_DMIC\_NG2**

Address: Operational Base + offset (0x002d)

Bit	Attr	Reset Value	Description
7:1	RO	0x00	RESV Reserved
0	RO	0x0	NGVALID_LI Noise gate valid status

**CODEC\_ADAC\_CFG1**

Address: Operational Base + offset (0x002f)

Bit	Attr	Reset Value	Description
7	RW	0x0	DOUBLE_DACIBIAS double DAC internal current resource
6	RW	0x0	INC_DAC_SWITCH increase the DAC internal switch signal control time
5	RW	0x0	STOP_DAC_RSTB stop the RSTB clock
4	RW	0x0	STOP_DAC_SWITCH stop the switch clock in DAC

Bit	Attr	Reset Value	Description
3	RW	0x0	PWD_DACIBIAS power down the DAC internal current resource 0: DACIBIAS powerup 1: DACIBIAS powerdown
2	RW	0x1	PWD_DACD Class D DAC power down 0: Class D DAC power up 1: Class D DAC power down
1	RW	0x1	PWD_DACL L channel DAC power down 0: L channel DAC power up 1: L channel DAC power down
0	RW	0x1	PWD_DACR R channel DAC power down 0: R channel DAC power up 1: R channel DAC power down

**CODEC\_DDAC\_POPD\_DACST**

Address: Operational Base + offset (0x0030)

Bit	Attr	Reset Value	Description
7	RW	0x1	ATCTRL auto-control power on and power down 0: automatic power control is disabled 1: automatic power control is enabled
6	RW	0x0	RESV Reserved
5	RW	0x0	SMTPO smart power on 0:smart power on is disabled 1:smart power on is enabled
4	RW	0x0	SMTPD smart power down 0:smart power down is disabled 1:smart power down is enabled
3:2	RW	0x0	RESV Reserved
1	RO	0x1	DAC_MTST DAC mute status 0:DAC is not in mute status 1:DAC is in mute status

Bit	Attr	Reset Value	Description
0	RO	0x0	DAC_PWRST DAC power status 0: DAC is powered down 1: DAC is powered on

**CODEC\_DDAC\_VOLL**

Address: Operational Base + offset (0x0031)

Bit	Attr	Reset Value	Description
7:0	RW	0x00	DACLV DAC path L-channel Digital Volume Register 0db~-95db,0.375db/step

**CODEC\_DDAC\_VOLR**

Address: Operational Base + offset (0x0032)

Bit	Attr	Reset Value	Description
7:0	RW	0x00	DACRV DAC path R-channel Digital Volume Register 0db~-95db,0.375db/step

**CODEC\_DDAC\_SR\_LMT0**

Address: Operational Base + offset (0x0035)

Bit	Attr	Reset Value	Description
7	RW	0x0	LIMEN LIMITER enable; 0:disable 1:enable
6	RW	0x0	LIMCHL 0:(left+right)/2 1:independent
5	RW	0x0	DAC_LV_POL 0: negative gain; 1:postive gain
4	RW	0x0	DAC_RV_POL 0: negative gain; 1:postive gain
3	RW	0x0	RESV Reserved
2:0	RW	0x0	DACSRT DAC sample rate times sample rate = 8k/11.025k/12k * power(2,DACSRT)

**CODEC\_DDAC\_LMT1**

Address: Operational Base + offset (0x0036)

Bit	Attr	Reset Value	Description
7:4	RW	0x0	LIMRRATE LIMITER Release rate= $8 * \text{power}(2, \text{LIMRRATE})$ samples
3:0	RW	0x0	LIMARATE LIMITER attack rate= $8 * \text{power}(2, \text{LIMARATE})$ samples

**CODEC\_DDAC\_LMT2**

Address: Operational Base + offset (0x0037)

Bit	Attr	Reset Value	Description
7	RW	0x0	RESV Reserved
6:4	RW	0x0	LIMMAX The highest threshold of LIMITER; 000~100:0db~-12db,3db/step; 101~111:-18db~-30db,6db/step;
3	RW	0x0	RESV Reserved
2:0	RW	0x0	LIMMIN The lowest threshold of LIMITER;

**CODEC\_DDAC\_MUTE\_MIXCTL**

Address: Operational Base + offset (0x0038)

Bit	Attr	Reset Value	Description
7	RW	0x1	DAC_D_HPF 0:disable HPF;1:enable HPF;
6:5	RW	0x1	DAC_D_HPF_CF 00:80HZ; 01:100HZ; 02:120HZ; 03:140HZ
4	RW	0x0	CLASS_D_MODE 1:CLASS D mode, 0:L/R mode
3	RW	0x0	CLASSD_MODE_L_SEL 0: (L+R)/2; 1: L
2	RW	0x0	RESV Reserved
1	RW	0x0	MIX_ON 0:mixer disable;1:enable;
0	RW	0x0	DACMT DAC mute enable 0:DAC mute is disabled 1:DAC mute is enable

**CODEC\_DDAC\_RVOLL**

Address: Operational Base + offset (0x0039)

Bit	Attr	Reset Value	Description
7:0	RO	0xff	DACRLV DAC internal gain of left ch

**CODEC\_DDAC\_RVOLR**

Address: Operational Base + offset (0x003a)

Bit	Attr	Reset Value	Description
7:0	RO	0xff	DACRRV DAC internal gain of right ch

**CODEC\_AHP\_ANTIO**

Address: Operational Base + offset (0x003b)

Bit	Attr	Reset Value	Description
7:5	RW	0x0	RESV Reserved
4:0	RW	0x00	STEP_CTRL STEP_CTRL for HP power on

**CODEC\_AHP\_ANTI1**

Address: Operational Base + offset (0x003c)

Bit	Attr	Reset Value	Description
7:5	RW	0x0	RESV Reserved
4:0	RW	0x00	VOUT_CTRL VOUT_CTRL for HP power on

**CODEC\_AHP\_CFG0**

Address: Operational Base + offset (0x003d)

Bit	Attr	Reset Value	Description
7	RW	0x1	PWD_SOSTAGE power down the HP SOSTAGE 0:power up 1:power down
6	RW	0x1	PWD_HP_OSTAGE power down the HP OSTAGE 0:power up 1:power down
5	RW	0x1	PWD_HP_BUF power down the HP pre amp stage 0:power up 1:power down
4:3	RW	0x0	INC_HP_AMP increase the HP amplitude from 3dB to 9dB, 00:0db 01:3db 10:6db 11: 9db

Bit	Attr	Reset Value	Description
2	RW	0x0	HP_2STAGE_EN Power down the HP two stage opamp 0:disable 1:enable
1:0	RW	0x0	HP_IBIAS_SEL HP BIAS current select 00:100% 01:150% 10:200% 11:50%

**CODEC\_AHP\_CFG1**

Address: Operational Base + offset (0x003e)

Bit	Attr	Reset Value	Description
7:5	RW	0x0	RESV Reserved
4	RW	0x1	HP_ANTIPOP_EN enable the HP antipop function 0:disable 1:enable
3:0	RW	0xf	HP_ANTIPOP_BIT control the HP antipop gain from -15dB to 0dB 0000: 0dB 0001:-1dB 0010:-2dB ... 1111:-15dB

**CODEC\_AHP\_CP**

Address: Operational Base + offset (0x003f)

Bit	Attr	Reset Value	Description
7:6	RW	0x0	RESV Reserved
5	RW	0x0	HP_CP_CLK_SEL 0: CLK select for head phone charge pump 1MHz :500KHz
4	RW	0x0	HP_CP_EN HP charge pump enable. 0:disable 1:enable
3	RW	0x1	HP_CP_ENDIS_LDO HP charge pump discharge ldo enable 0:disable 1:enable
2	RW	0x0	HP_CP_HIMAXB HP charge pump max current: 0:500mA,1:750mA

Bit	Attr	Reset Value	Description
1:0	RW	0x1	HP_CP_VSEL HP charge pump voltage select: 00:2.1V,01:2.3V,10:2.5V,11:2.7V

**CODEC\_ACLASD\_CFG1**

Address: Operational Base + offset (0x0040)

Bit	Attr	Reset Value	Description
7	RW	0x0	CLASSD_EN CLASS D enable 0:disable 1:enable
6	RW	0x1	CLASSD_MUTE_EN CLASS D mute_ramp function enable 0:disable 1:enable
5	RW	0x1	CLASSD_SSC_EN CLASS D Spread-Spectrum enable 0:disable 1:enable
4	RW	0x0	CLASSD_SSC_SEL CLASS D Spread-Spectrum steps select 0: 8 steps 1:16 step
3:2	RW	0x2	CLASSD_MUTE_RATE 00:0ms;01:16ms;10:32ms;11:64ms
1:0	RW	0x1	CLASSD_SW_RATE 00:2.5ns;01:5ns;10:7.5ns;11:10ns

**CODEC\_ACLASD\_CFG2**

Address: Operational Base + offset (0x0041)

Bit	Attr	Reset Value	Description
7	RO	0x0	CLASSD_OCP_STS IF this bit is high, it need to restart CLASS D.
6:4	RW	0x4	CLASSD_OCPS CLASS D PFET OCP Select 000: 0.5A 001: 0.625A 010: 0.75A 011: 0.875A 100:1A (Default) 101: 1.125A 110: 1.25A 111: 1.375A
3	RO	0x0	CLASSD_MUTE_DONE When class d mute finished, this bit will be set high.
2:0	RW	0x4	CLASSD_OCPN CLASS D NFET OCP Select 000: 0.5A 001: 0.625A 010: 0.75A 011: 0.875A 100:1A (Default) 101: 1.125A 110: 1.25A 111: 1.375A

**CODEC\_APLL\_CFG0**

Address: Operational Base + offset (0x0042)

Bit	Attr	Reset Value	Description
7:4	RW	0x0	RESV Reserved
3	RW	0x0	PLL_CLKIN_SEL the PLL input clock select, 0->main clk 1->main clk/2
2	RW	0x1	PLL_OUTDIV_EN enable PLL VCO output clock divide 0:disable 1:enable
1:0	RW	0x0	PLL_VCO_BANDSEL PLL VCO working band select

**CODEC\_APLL\_CFG1**

Address: Operational Base + offset (0x0043)

Bit	Attr	Reset Value	Description
7:6	RW	0x0	PLL_RES_SEL PLL filter resistor value select
5:3	RW	0x0	PLL_CUR_SEL PLL charge-pump working current select
2:0	RW	0x0	PLL_POSDIV_L3 PLL feedback clock divide value select low 3 bits

**CODEC\_APLL\_CFG2**

Address: Operational Base + offset (0x0044)

Bit	Attr	Reset Value	Description
7:0	RW	0x30	PLL_POSDIV_H8 PLL feedback clock divide value select high 8 bits

**CODEC\_APLL\_CFG3**

Address: Operational Base + offset (0x0045)

Bit	Attr	Reset Value	Description
7:0	RW	0x19	PLL_PREDIV_BIT PLL input clock pre-divide value select

**CODEC\_APLL\_CFG4**

Address: Operational Base + offset (0x0046)

Bit	Attr	Reset Value	Description
7:4	RW	0x6	PLL_OUTDIV PLL VCO output clock divide value select outdiv<3:2>: 00-> divide 5 01-> divide 10 10-> divide 3 11-> divide 6 outdiv<1:0>: 00-> divide 3 01-> divide 1 10-> divide 2 11-> divide 1"
3:0	RW	0x5	PLL_CLK_DIV PLL divided ratio of PLL_HIGH_clk, 0000->divided 1 and 1111->divided 15

**CODEC\_APLL\_CFG5**

Address: Operational Base + offset (0x0047)

Bit	Attr	Reset Value	Description
7:3	RW	0x00	RESV Reserved
2	RW	0x0	PLL_RESET reset the total PLL register 0:release reset 1:set reset
1	RW	0x0	PLL_TEST check the PLL internal VCO control voltage 0:disable 1:enable
0	RW	0x1	PLL_PWD pll power down 0: PLL power up 1:PLL power down

**CODEC\_DI2S\_CKM**

Address: Operational Base + offset (0x0048)

Bit	Attr	Reset Value	Description
7:4	RW	0x0	SCK_DIV $F(mclk2x)/F(sclk) - 1$
3	RW	0x0	PDM_EN I2S SDO output delta-sigma ADC 1bit data. 0:disable; 1:enable.
2	RW	0x0	SCK_EN i2ssclk clock enable, active in master mode. 0:disable 1:enable
1	RW	0x0	SCK_P sclk polarity 0: normal 1:inverted

Bit	Attr	Reset Value	Description
0	RW	0x1	I2S_TX_MST I2S TX module as 0: slave mode 1: master mode

**CODEC\_DI2S\_RSD**

Address: Operational Base + offset (0x0049)

Bit	Attr	Reset Value	Description
7:4	RW	0x0	RESV Reserved
3	RW	0x0	PDM_LR_SEL 0: L; 1: R
2:1	RW	0x0	SCKD_RX sclk divider for rxlrck generator 00:64 01:128 10:256(01 valid only if lrclk<= 96k, 10 valid only if lrclk<= 48k)
0	RW	0x0	RXRL_P I2S Rx lrck polarity 0: normal 1:inverted

**CODEC\_DI2S\_RXCR1**

Address: Operational Base + offset (0x004a)

Bit	Attr	Reset Value	Description
7	RW	0x0	RESV Reserved
6	RW	0x0	TFS_RX Rx transfer mode selector: 0: I2S 1:PCM
5:4	RW	0x0	PBM_RX Rx PCM bus mode: 00: delay0 01:delay1 10: delay2 11:delay3
3:2	RW	0x0	IBM_RX Rx I2S bus mode: 00: normal 01:left 10:right
1	RW	0x0	EXRL_RX Rx exchange right/left channel for rx 0: normal 1:exchange right and left channel
0	RW	0x0	LSB_RX 0: LSB 1:MSB

**CODEC\_DI2S\_RXCR2**

Address: Operational Base + offset (0x004b)

Bit	Attr	Reset Value	Description
7:5	RW	0x0	RESV Reserved
4:0	RW	0x17	VDW_RX valid data width 0x17: 24 bits data width; 0x0F: 16 bits data width; others: reserved

**CODEC\_DI2S\_RXCMD\_TSD**

Address: Operational Base + offset (0x004c)

Bit	Attr	Reset Value	Description
7:6	RW	0x0	RESV Reserved
5	RW	0x0	RXS rx transfer start 0: rx stop 1:rx start
4	RW	0x0	RXC rx transfer clear, high active
3	RW	0x0	RESV Reserved
2:1	RW	0x0	SCKD_TX sclk divider for txlrck generator 00:64 01:128 10:256(01 valid only if lrcclk<= 96k, 10 valid only if lrcclk<= 48k)
0	RW	0x0	TXRL_P I2S Txlrck polarity 0:normal 1:inverted

**CODEC\_DI2S\_TXCR1**

Address: Operational Base + offset (0x004d)

Bit	Attr	Reset Value	Description
7	RW	0x0	RESV Reserved
6	RW	0x0	TFS_TX Tx transfer mode selector: 0: I2S 1:PCM
5:4	RW	0x0	PBM_TX Tx PCM bus mode: 00: delay0 01: delay1 10: delay2

Bit	Attr	Reset Value	Description
3:2	RW	0x0	IBM_TX Tx I2S bus mode: 00: normal 01:left 10:right
1	RW	0x0	EXRL_TX Tx exchange right/left channel for TX 0: normal 1:exchange right and left channel
0	RW	0x0	LSB_TX 0: LSB 1:MSB

**CODEC\_DI2S\_TXCR2**

Address: Operational Base + offset (0x004e)

Bit	Attr	Reset Value	Description
7:5	RW	0x0	RESV Reserved
4:0	RW	0x17	VDW_TX valid data width 0x17: 24 bits data width; 0x0F: 16 bits data width; others: reserved

**CODEC\_DI2S\_TXCR3\_TXCMD**

Address: Operational Base + offset (0x004f)

Bit	Attr	Reset Value	Description
7	RW	0x0	TXS tx transfer start 0: tx stop 1:tx start
6	RW	0x0	TXC tx transfer clear, high active
5:0	RW	0x00	RCNT_TX right justified counter for I2S right justified slave mode only

**gas\_gauge\_ADC\_CONFIG0**

Address: Operational Base + offset (0x0050)

Bit	Attr	Reset Value	Description
7	RW	0x1	GG_EN GG_EN: Gasgauge module enable bit 0:disable 1: enable
6	RW	0x0	SYS_VOL_ADC_EN SYS_VOL_ADC_EN: if GG_EN=0, then the ADC of SYS voltage controlled by the bit 0:disable 1:enable

Bit	Attr	Reset Value	Description
5	RW	0x0	TS_ADC_EN TS_ADC_EN: if GG_EN=0, the ADC of TS1 controlled by the bit 0:disable 1:enable
4	RW	0x0	USB_VOL_ADC_EN USB_VOL_ADC_EN: if GG_EN=0, the ADC of USB voltage by the bit 0:disable 1:enable
3	RW	0x1	BAT_VOL_ADC_EN BAT_VOL_ADC_EN: if GG_EN=0, then the ADC of BAT voltage controlled by the bit 0:disable 1:enable
2	RW	0x1	BAT_CUR_ADC_EN BAT_CUR_ADC_EN: if GG_EN=0, then the ADC of BAT current controlled by the bit 0:disable 1:enable
1	RW	0x0	RESV RESV:Reserve
0	RW	0x0	ADC_SLP_RATE ADC_SLP_RATE: the ADC sample rate: 0:512; 1:1024

**gas\_gauge\_ADC\_CONFIG1**

Address: Operational Base + offset (0x0055)

Bit	Attr	Reset Value	Description
7	RC	0x0	VOL_CUR_CALIB_UPD VOL_CUR_CALIB_UPD: The voltage ADC and current ADC calibration finished status 0:not finished 1:finished (Write "1" to clear)
6	RW	0x0	RESV RESV:Reserve
5:4	RW	0x3	VOL_ADC_TSCUR_SEL VOL_ADC_TSCUR_SEL: TS pin flow out current in active state 00:10uA 01:20uA 10:30uA 11:40uA
3	RW	0x0	TS_FUN TS_FUN: TS pin function selection 0:source current to TS pin 1:external voltage input directly
2	RW	0x0	RESV RESV:Reserve

Bit	Attr	Reset Value	Description
1:0	RW	0x0	RLX_CUR_FILTER RLX_CUR_FILTER: Relax mode enter threshold filter. 00:4S; 01:1S; 10:2S; 11:8S;

**gas\_gauge\_GG\_CON**

Address: Operational Base + offset (0x0056)

Bit	Attr	Reset Value	Description
7:6	RW	0x1	RLX_SPT RLX_SPT: relax mode voltage sampling interval time T_RELAX: Relax mode enter and quit time 00:8min 01:16min 10:32min 11:48min
5:4	RW	0x0	ADC_OFF_CAL_INTERV ADC_OFF_CAL_INTERV<1:0>: ADC offset calibration interval time 00:8min 01:16min 10:32min 11:48min
3:2	RW	0x1	FRAME_SMP_INTERV FRAME_SMP_INTERV<1:0>:Data frame sample interval in the sleep state(Unit:S) 00:0S 01:1S 10:2S 11:3S
1	RW	0x0	VOL_OUT_MOD VOL_OUT_MOD: Voltage output mode 0:Average Voltage 1:Instant Voltage
0	RW	0x0	CUR_OUT_MOD CUR_OUT_MOD: Current output mode 0:Average Current 1:Instant Current

**gas\_gauge\_GG\_STS**

Address: Operational Base + offset (0x0057)

Bit	Attr	Reset Value	Description
7	RO	0x0	OCV_STS OCV_STS: OCV mode status. 1: ocv mode; 0: null ocv mode.
6	RO	0x0	TERM_UPD TERM_UPD: Flag bit for Q_TERM update 0: NOT 1:YES
5	RW	0x0	QMAX_UPD_SOFT QMAX_UPD_SOFT: software Flag bit for QMAX update 0: NOT 1:YES

Bit	Attr	Reset Value	Description
4	RO	0x0	BAT_CON BAT_CON: battery first connection, edge trigger 0:NOT 1:YES
3	RO	0x0	RELAX_VOL1_UPD RELAX_VOL1_UPD: battery voltage1 updated in relax status 0:NOT 1:YES
2	RO	0x0	RELAX_VOL2_UPD RELAX_VOL2_UPD: battery voltage2 updated in relax status 0:NOT 1:YES
1	RO	0x0	RELAX_STS RELAX_STS: battery coming into relax status 0:NOT 1:YES
0	RO	0x0	OCV_UPD OCV_UPD: Flag bit for OCV update 0: NOT 1:YES

**gas\_gauge\_RELAX\_THRE\_H**

Address: Operational Base + offset (0x0058)

Bit	Attr	Reset Value	Description
7:0	RW	0x00	RELAX_THRE_CUR RELAX_THRE_CUR: relax mode threshold current set.<15:8>

**gas\_gauge\_RELAX\_THRE\_L**

Address: Operational Base + offset (0x0059)

Bit	Attr	Reset Value	Description
7:0	RW	0x60	RELAX_THRE_CUR RELAX_THRE_CUR: relax mode threshold current set. <7:0>

**gas\_gauge\_RELAX\_VOL1\_H**

Address: Operational Base + offset (0x005a)

Bit	Attr	Reset Value	Description
7:0	RO	0x00	RELAX_VOL1_H RELAX_VOL1_H<15:8>: relax 1st mode voltage

**gas\_gauge\_RELAX\_VOL1\_L**

Address: Operational Base + offset (0x005b)

Bit	Attr	Reset Value	Description
7:0	RO	0x00	RELAX_VOL1_L RELAX_VOL1_L<7:0>: relax 1st mode voltage

**gas\_gauge\_RELAX\_VOL2\_H**

Address: Operational Base + offset (0x005c)

Bit	Attr	Reset Value	Description
7:0	RO	0x00	RELAX_VOL2 RELAX_VOL2<15:8>: relax 2nd mode voltage

**gas\_gauge\_RELAX\_VOL2\_L**

Address: Operational Base + offset (0x005d)

Bit	Attr	Reset Value	Description
7:0	RO	0x00	RELAX_VOL2 RELAX_VOL2<7:0>: relax 2nd mode voltage

**gas\_gauge\_RELAX\_CUR1\_H**

Address: Operational Base + offset (0x005e)

Bit	Attr	Reset Value	Description
7:0	RO	0x00	RELAX_CUR1 RELAX_CUR1<15:8>:relax 1st mode current

**gas\_gauge\_RELAX\_CUR1\_L**

Address: Operational Base + offset (0x005f)

Bit	Attr	Reset Value	Description
7:0	RO	0x00	RELAX_CUR1 RELAX_CUR1<7:0>: relax 1st mode current

**gas\_gauge\_RELAX\_CUR2\_H**

Address: Operational Base + offset (0x0060)

Bit	Attr	Reset Value	Description
7:0	RO	0x00	RELAX_CUR2 RELAX_CUR2<15:8>: relax 2nd mode current

**gas\_gauge\_RELAX\_CUR2\_L**

Address: Operational Base + offset (0x0061)

Bit	Attr	Reset Value	Description
7:0	RO	0x00	RELAX_CUR2 RELAX_CUR2<7:0>: relax 2nd mode current

**gas\_gauge\_OCV\_THRE\_VOL**

Address: Operational Base + offset (0x0062)

Bit	Attr	Reset Value	Description
7:0	RW	0x00	OCV_THRE_VOL OCV_THRE_VOL:OCV mode threshold. 00:0.5mV; 01:1mV; 02:1.5mV.....FF:127.5mV

**gas\_gauge\_OCV\_VOL\_H**

Address: Operational Base + offset (0x0063)

Bit	Attr	Reset Value	Description
7:0	RO	0x00	OCV_VOL_REG OCV_VOL_REG<15:8>: OCV voltage

**gas\_gauge\_OCV\_VOL\_L**

Address: Operational Base + offset (0x0064)

Bit	Attr	Reset Value	Description
7:0	RO	0x00	OCV_VOL_REG OCV_VOL_REG<7:0>:OCV voltage

**gas\_gauge\_OCV\_VOLO\_H**

Address: Operational Base + offset (0x0065)

Bit	Attr	Reset Value	Description
7:0	RO	0x00	OCV_VOLO_REG OCV_VOLO_REG<15:8>:OCV voltage 0

**gas\_gauge\_OCV\_VOLO\_L**

Address: Operational Base + offset (0x0066)

Bit	Attr	Reset Value	Description
7:0	RO	0x00	OCV_VOLO_REG OCV_VOLO_REG<7:0>:OCV voltage 0

**gas\_gauge\_OCV\_CUR\_H**

Address: Operational Base + offset (0x0067)

Bit	Attr	Reset Value	Description
7:0	RO	0x00	OCV_CUR_REG OCV_CUR_REG<15:8>:OCV current

**gas\_gauge\_OCV\_CUR\_L**

Address: Operational Base + offset (0x0068)

Bit	Attr	Reset Value	Description
7:0	RO	0x00	OCV_CUR_REG OCV_CUR_REG<7:0>:OCV current

**gas\_gauge\_OCV\_CUR0\_H**

Address: Operational Base + offset (0x0069)

Bit	Attr	Reset Value	Description
7:0	RO	0x00	OCV_CUR0_REG OCV_CUR0_REG<15:8>: OCV current 0

**gas\_gauge\_OCV\_CUR0\_L**

Address: Operational Base + offset (0x006a)

Bit	Attr	Reset Value	Description
7:0	RO	0x00	OCV_CUR0_REG OCV_CUR0_REG<7:0>: OCV current 0

**gas\_gauge\_PWRON\_VOL\_H**

Address: Operational Base + offset (0x006b)

Bit	Attr	Reset Value	Description
7:0	RO	0x00	PWRON_VOL_REG PWRON_VOL_REG<15:8>: power on bat voltage

**gas\_gauge\_PWRON\_VOL\_L**

Address: Operational Base + offset (0x006c)

Bit	Attr	Reset Value	Description
7:0	RO	0x00	PWRON_VOL_REG PWRON_VOL_REG<7:0>: power on bat voltage

**gas\_gauge\_PWRON\_CUR\_H**

Address: Operational Base + offset (0x006d)

Bit	Attr	Reset Value	Description
7:0	RO	0x00	PWRON_CUR_REG PWRON_CUR_REG<15:8>: power on bat current

**gas\_gauge\_PWRON\_CUR\_L**

Address: Operational Base + offset (0x006e)

Bit	Attr	Reset Value	Description
7:0	RO	0x00	PWRON_CUR_REG PWRON_CUR_REG<7:0>: power on bat current

**gas\_gauge\_OFF\_CNT**

Address: Operational Base + offset (0x006f)

Bit	Attr	Reset Value	Description
7:0	RW	0x00	OFF_CNT OFF_CNT<7:0>: power off time

**gas\_gauge\_Q\_INIT\_H3**

Address: Operational Base + offset (0x0070)

Bit	Attr	Reset Value	Description
7:0	RW	0x00	Q_INIT Q_INIT<31:24>:power off time

**gas\_gauge\_Q\_INIT\_H2**

Address: Operational Base + offset (0x0071)

Bit	Attr	Reset Value	Description
7:0	RW	0x00	Q_INIT Q_INIT<23:16>:power off time

**gas\_gauge\_Q\_INIT\_L1**

Address: Operational Base + offset (0x0072)

Bit	Attr	Reset Value	Description
7:0	RW	0x00	Q_INIT Q_INIT<15:8>:power off time

**gas\_gauge\_Q\_INIT\_L0**

Address: Operational Base + offset (0x0073)

Bit	Attr	Reset Value	Description
7:0	RW	0x00	Q_INIT Q_INIT<7:0>:power off time

**gas\_gauge\_Q\_PRES\_H3**

Address: Operational Base + offset (0x0074)

Bit	Attr	Reset Value	Description
7:0	RO	0x00	Q_PRES Q_PRES<31:24>:Coulomp value

**gas\_gauge\_Q\_PRES\_H2**

Address: Operational Base + offset (0x0075)

Bit	Attr	Reset Value	Description
7:0	RO	0x00	Q_PRES Q_PRES<23:16>:Coulomp value

**gas\_gauge\_Q\_PRES\_L1**

Address: Operational Base + offset (0x0076)

Bit	Attr	Reset Value	Description
7:0	RO	0x00	Q_PRES Q_PRES<15:8>:Coulomp value

**gas\_gauge\_Q\_PRES\_L0**

Address: Operational Base + offset (0x0077)

Bit	Attr	Reset Value	Description
7:0	RO	0x00	Q_PRES Q_PRES<7:0>:Coulomp value

**gas\_gauge\_BAT\_VOL\_H**

Address: Operational Base + offset (0x0078)

Bit	Attr	Reset Value	Description
7:0	RO	0x00	BAT_VOL BAT_VOL<15:8>: bat voltage

**gas\_gauge\_BAT\_VOL\_L**

Address: Operational Base + offset (0x0079)

Bit	Attr	Reset Value	Description
7:0	RO	0x00	BAT_VOL BAT_VOL<7:0>:bat voltage

**gas\_gauge\_BAT\_CUR\_H**

Address: Operational Base + offset (0x007a)

Bit	Attr	Reset Value	Description
7:0	RO	0x00	BAT_CUR BAT_CUR<15:8>:battery current

**gas\_gauge\_BAT\_CUR**

Address: Operational Base + offset (0x007b)

Bit	Attr	Reset Value	Description
7:0	RO	0x00	BAT_CUR BAT_CUR<7:0>:BAT_CUR: battery current

**gas\_gauge\_BAT\_TS\_H**

Address: Operational Base + offset (0x007c)

Bit	Attr	Reset Value	Description
7:0	RO	0x00	BAT_TS BAT_TS<15:8>:TS ADC value

**gas\_gauge\_BAT\_TS\_L**

Address: Operational Base + offset (0x007d)

Bit	Attr	Reset Value	Description
7:0	RO	0x00	BAT_TS BAT_TS<7:0>: TS ADC value

**gas\_gauge\_USB\_VOL\_H**

Address: Operational Base + offset (0x007e)

Bit	Attr	Reset Value	Description
7:0	RO	0x00	USB_VOL USB_VOL<15:8>: USB voltage value

**gas\_gauge\_USB\_VOL\_L**

Address: Operational Base + offset (0x007f)

Bit	Attr	Reset Value	Description
7:0	RO	0x00	USB_VOL USB_VOL<7:0>: USB voltage value

**gas\_gauge\_SYS\_VOL\_H**

Address: Operational Base + offset (0x0080)

Bit	Attr	Reset Value	Description
7:0	RO	0x00	SYS_VOL SYS_VOL<15:8>: SYS voltage value

**gas\_gauge\_SYS\_VOL\_L**

Address: Operational Base + offset (0x0081)

Bit	Attr	Reset Value	Description
7:0	RO	0x00	SYS_VOL SYS_VOL<7:0>: SYS voltage value

**gas\_gauge\_Q\_MAX\_H3**

Address: Operational Base + offset (0x0082)

Bit	Attr	Reset Value	Description
7:0	RW	0x00	Q_MAX Q_MAX<31:24>: Qmax value

**gas\_gauge\_Q\_MAX\_H2**

Address: Operational Base + offset (0x0083)

Bit	Attr	Reset Value	Description
7:0	RW	0x00	Q_MAX Q_MAX<23:16>: Qmax value

**gas\_gauge\_Q\_MAX\_L1**

Address: Operational Base + offset (0x0084)

Bit	Attr	Reset Value	Description
7:0	RW	0x00	Q_MAX Q_MAX<15:8>: Qmax value

**gas\_gauge\_Q\_MAX\_L0**

Address: Operational Base + offset (0x0085)

Bit	Attr	Reset Value	Description
7:0	RW	0x00	Q_MAX Q_MAX<7:0>: Qmax value

**gas\_gauge\_Q\_TERM\_H3**

Address: Operational Base + offset (0x0086)

Bit	Attr	Reset Value	Description
7:0	RO	0x00	Q_TERM Q_TERM<31:24>: charge terminal Coulomp value

**gas\_gauge\_Q\_TERM\_H2**

Address: Operational Base + offset (0x0087)

Bit	Attr	Reset Value	Description
7:0	RO	0x00	Q_TERM Q_TERM<23:16>: charge terminal Coulomp value

**gas\_gauge\_Q\_TERM\_L1**

Address: Operational Base + offset (0x0088)

Bit	Attr	Reset Value	Description
7:0	RO	0x00	Q_TERM Q_TERM<15:8>: charge terminal Coulomp value

**gas\_gauge\_Q\_TERM\_L0**

Address: Operational Base + offset (0x0089)

Bit	Attr	Reset Value	Description
7:0	RO	0x00	Q_TERM Q_TERM<7:0>: charge terminal Coulomp value

**gas\_gauge\_Q\_OCV\_H3**

Address: Operational Base + offset (0x008a)

Bit	Attr	Reset Value	Description
7:0	RO	0x00	Q_OCV Q_OCV<31:24>:OCV update Coulomp value

**gas\_gauge\_Q\_OCV\_H2**

Address: Operational Base + offset (0x008b)

Bit	Attr	Reset Value	Description
7:0	RO	0x00	Q_OCV Q_OCV<23:16>:OCV update Coulomp value

**gas\_gauge\_Q\_OCV\_L1**

Address: Operational Base + offset (0x008c)

Bit	Attr	Reset Value	Description
7:0	RO	0x00	Q_OCV Q_OCV<15:8>:OCV update Coulomp value

**gas\_gauge\_Q\_OCV\_L0**

Address: Operational Base + offset (0x008d)

Bit	Attr	Reset Value	Description
7:0	RO	0x00	Q_OCV Q_OCV<7:0>:OCV update Coulomp value

**gas\_gauge\_OCV\_CNT**

Address: Operational Base + offset (0x008e)

Bit	Attr	Reset Value	Description
7:0	RW	0x00	OCV_CNT OCV_CNT<7:0>: two OCV time interval

**gas\_gauge\_SLEEP\_CON\_SAMP\_CUR\_H**

Address: Operational Base + offset (0x008f)

Bit	Attr	Reset Value	Description
7:0	RW	0x00	SLEEP_CON_SAMP_CUR SLEEP_CON_SAMP_CUR<15:8>:SLEEP mode, When the current is greater than the set value, it is sampled once again, until it is less than the set value, and the value is updated to the RELAX register

**gas\_gauge\_SLEEP\_CON\_SAMP\_CUR**

Address: Operational Base + offset (0x0090)

Bit	Attr	Reset Value	Description
7:0	RW	0x60	SLEEP_CON_SAMP_CUR SLEEP_CON_SAMP_CUR<7:0>: SLEEP mode, When the current is greater than the set value, it is sampled once again, until it is less than the set value, and the value is updated to the RELAX register

**gas\_gauge\_CAL\_OFFSET\_H**

Address: Operational Base + offset (0x0091)

Bit	Attr	Reset Value	Description
7:0	RW	0x7f	CAL_OFFSET_REG CAL_OFFSET_REG<15:8>: PCB current offset value high bit

**gas\_gauge\_CAL\_OFFSET\_L**

Address: Operational Base + offset (0x0092)

Bit	Attr	Reset Value	Description
7:0	RW	0xff	CAL_OFFSET_REG CAL_OFFSET_REG<7:0>: PCB current offset value low bit

### gas\_gauge\_VCALIB0\_H

Address: Operational Base + offset (0x0093)

Bit	Attr	Reset Value	Description
7:0	RO	0x00	VCALIB0 VCALIB0<15:8>:Voltage0 offset value for AP to calculate offset error and gain error

### gas\_gauge\_VCALIB0\_L

Address: Operational Base + offset (0x0094)

Bit	Attr	Reset Value	Description
7:0	RO	0x00	VCALIB0 VCALIB0<7:0>:Voltage0 offset value for AP to calculate offset error and gain error

### gas\_gauge\_VCALIB1\_H

Address: Operational Base + offset (0x0095)

Bit	Attr	Reset Value	Description
7:0	RO	0x00	VCALIB1 VCALIB1<15:8>:Voltage1 offset value for AP to calculate offset error and gain error

### gas\_gauge\_VCALIB1\_L

Address: Operational Base + offset (0x0096)

Bit	Attr	Reset Value	Description
7:0	RO	0x00	VCALIB1 VCALIB1<7:0>:Voltage1 offset value for AP to calculate offset error and gain error

### gas\_gauge\_IOFFSET\_H

Address: Operational Base + offset (0x0097)

Bit	Attr	Reset Value	Description
7:0	RO	0x00	IOFFSET IOFFSET<15:8>:Current offset value calculated

**gas\_gauge\_IOFFSET\_L**

Address: Operational Base + offset (0x0098)

Bit	Attr	Reset Value	Description
7:0	RO	0x00	IOFFSET IOFFSET<7:0>:Current offset value calculated

**gas\_gauge\_BAT\_R0**

Address: Operational Base + offset (0x0099)

Bit	Attr	Reset Value	Description
7:0	RW	0x00	BAT_R0 BAT_R0<7:0>:BAT resistance

**gas\_gauge\_BAT\_R1**

Address: Operational Base + offset (0x009a)

Bit	Attr	Reset Value	Description
7:0	RW	0x00	BAT_R1 BAT_R1<7:0>:BAT resistance

**gas\_gauge\_BAT\_R2**

Address: Operational Base + offset (0x009b)

Bit	Attr	Reset Value	Description
7:0	RW	0x00	BAT_R2 BAT_R2<7:0>:BAT resistance

**gas\_gauge\_BAT\_R3**

Address: Operational Base + offset (0x009c)

Bit	Attr	Reset Value	Description
7:0	RW	0x00	BAT_R3 BAT_R3<7:0>:BAT resistance

**gas\_gauge\_DATA0**

Address: Operational Base + offset (0x009d)

Bit	Attr	Reset Value	Description
7:0	RW	0x00	DATA DATA<7:0>:data for AP

**gas\_gauge\_DATA1**

Address: Operational Base + offset (0x009e)

Bit	Attr	Reset Value	Description
7:0	RW	0x00	DATA DATA<7:0>:data for AP

**gas\_gauge\_DATA2**

Address: Operational Base + offset (0x009f)

Bit	Attr	Reset Value	Description
7:0	RW	0x00	DATA DATA<7:0>:data for AP

**gas\_gauge\_DATA3**

Address: Operational Base + offset (0x00a0)

Bit	Attr	Reset Value	Description
7:0	RW	0x00	DATA DATA<7:0>:data for AP

**gas\_gauge\_DATA4**

Address: Operational Base + offset (0x00a1)

Bit	Attr	Reset Value	Description
7:0	RW	0x00	DATA DATA<7:0>:data for AP

**gas\_gauge\_DATA5**

Address: Operational Base + offset (0x00a2)

Bit	Attr	Reset Value	Description
7:0	RW	0x00	DATA DATA<7:0>:data for AP

**gas\_gauge\_DATA6**

Address: Operational Base + offset (0x00a3)

Bit	Attr	Reset Value	Description
7:0	RW	0x00	DATA DATA<7:0>:data for AP

**gas\_gauge\_DATA7**

Address: Operational Base + offset (0x00a4)

Bit	Attr	Reset Value	Description
7:0	RW	0x00	DATA DATA<7:0>:data for AP

**gas\_gauge\_DATA8**

Address: Operational Base + offset (0x00a5)

Bit	Attr	Reset Value	Description
7:0	RW	0x00	DATA DATA<7:0>:data for AP

**gas\_gauge\_DATA9**

Address: Operational Base + offset (0x00a6)

Bit	Attr	Reset Value	Description
7:0	RW	0x00	DATA DATA<7:0>:data for AP

**gas\_gauge\_DATA10**

Address: Operational Base + offset (0x00a7)

Bit	Attr	Reset Value	Description
7:0	RW	0x00	DATA DATA<7:0>:data for AP

**gas\_gauge\_DATA11**

Address: Operational Base + offset (0x00a8)

Bit	Attr	Reset Value	Description
7:0	RW	0x00	DATA DATA<7:0>:data for AP

**gas\_gauge\_VOL\_ADC\_B3**

Address: Operational Base + offset (0x00a9)

Bit	Attr	Reset Value	Description
7:0	RO	OTP	VOL_ADC_B VOL_ADC_B<31:24>: default:OTP

**gas\_gauge\_VOL\_ADC\_B2**

Address: Operational Base + offset (0x00aa)

Register0000 Abstract

Bit	Attr	Reset Value	Description
7:0	RO	OTP	VOL_ADC_B VOL_ADC_B<23:16> default: OTP

**gas\_gauge\_VOL\_ADC\_B1**

Address: Operational Base + offset (0x00ab)

Register0000 Abstract

Bit	Attr	Reset Value	Description
7:0	RO	OTP	VOL_ADC_B VOL_ADC_B<15:8> default: OTP

**gas\_gauge\_VOL\_ADC\_B\_7\_0**

Address: Operational Base + offset (0x00ac)

Register0000 Abstract

Bit	Attr	Reset Value	Description
7:0	RO	OTP	VOL_ADC_B0 VOL_ADC_B<7:0> default: OTP

**gas\_gauge\_CUR\_ADC\_K3**

Address: Operational Base + offset (0x00ad)

Bit	Attr	Reset Value	Description
7:0	RO	OTP	CUR_ADC_K CUR_ADC_K<31:24> default: OTP

**gas\_gauge\_CUR\_ADC\_K2**

Address: Operational Base + offset (0x00ae)

Bit	Attr	Reset Value	Description
7:0	RO	OTP	CUR_ADC_K CUR_ADC_K<23:16> default: OTP

**gas\_gauge\_CUR\_ADC\_K1**

Address: Operational Base + offset (0x00af)

Bit	Attr	Reset Value	Description
7:0	RO	OTP	CUR_ADC_K CUR_ADC_K<15:8> default: OTP

**gas\_gauge\_CUR\_ADC\_K0**

Address: Operational Base + offset (0x00b0)

Bit	Attr	Reset Value	Description
7:0	RO	OTP	CUR_ADC_K0 CUR_ADC_K<7:0> default: OTP

**PMIC\_POWER\_EN0**

Address: Operational Base + offset (0x00b1)

Bit	Attr	Reset Value	Description
7	RW	0x0	BUCK4_EN_MASK BUCK4_EN_MASK: MUST write them to "1" if want to change corresponding BUCK4_EN bit, The BUCK4_EN_MASK bits should be clear when BUCK4_EN bits have been written.
6	RW	0x0	BUCK3_EN_MASK BUCK3_EN_MASK: MUST write them to "1" if want to change corresponding BUCK3_EN bit, The BUCK3_EN_MASK bits should be clear when BUCK3_EN bits have been written.
5	RW	0x0	BUCK2_EN_MASK BUCK2_EN_MASK: MUST write them to "1" if want to change corresponding BUCK2_EN bit, The BUCK2_EN_MASK bits should be clear when BUCK2_EN bits have been written.
4	RW	0x0	BUCK1_EN_MASK BUCK1_EN_MASK: MUST write them to "1" if want to change corresponding BUCK1_EN bit, The BUCK1_EN_MASK bits should be clear when BUCK1_EN bits have been written.
3	RW	OTP	BUCK4_EN BUCK4_EN: BUCK4 enable in active mode 1, Enable 0, Disable the default value is set by otp reset by power down or RST.
2	RW	OTP	BUCK3_EN BUCK3_EN: BUCK3 enable in active mode 1, Enable 0, Disable the default value is set by otp reset by power down or RST.

Bit	Attr	Reset Value	Description
1	RW	OTP	BUCK2_EN BUCK2_EN: BUCK2 enable in active mode 1, Enable 0, Disable the default value is set by otp reset by power down or RST.
0	RW	OTP	BUCK1_EN BUCK1_EN: BUCK1 enable in active mode 1, Enable 0, Disable the default value is set by otp reset by power down or RST.

**PMIC\_POWER\_EN1**

Address: Operational Base + offset (0x00b2)

Bit	Attr	Reset Value	Description
7	RW	0x0	LDO4_EN_MASK LDO4_EN_MASK: MUST write them to "1" if want to change corresponding LDO4_EN bit, The LDO4_EN_MASK bits should be clear when LDO4_EN bits have been written.
6	RW	0x0	LDO3_EN_MASK LDO3_EN_MASK: MUST write them to "1" if want to change corresponding LDO3_EN bit, The LDO3_EN_MASK bits should be clear when LDO3_EN bits have been written.
5	RW	0x0	LDO2_EN_MASK LDO2_EN_MASK: MUST write them to "1" if want to change corresponding LDO2_EN bit, The LDO2_EN_MASK bits should be clear when LDO2_EN bits have been written.
4	RW	0x0	LDO1_EN_MASK LDO1_EN_MASK: MUST write them to "1" if want to change corresponding LDO1_EN bit, The LDO1_EN_MASK bits should be clear when LDO1_EN bits have been written.
3	RW	OTP	LDO4_EN LDO4_EN: LDO4 enable in active mode 1, Enable 0, Disable the default value is set by otp reset by power down or RST.

Bit	Attr	Reset Value	Description
2	RW	OTP	LDO3_EN LDO3_EN: LDO3 enable in active mode 1, Enable 0, Disable the default value is set by otp reset by power down or RST.
1	RW	OTP	LDO2_EN LDO2_EN: LDO2 enable in active mode 1, Enable 0, Disable the default value is set by otp reset by power down or RST.
0	RW	OTP	LDO1_EN LDO1_EN: LDO1 enable in active mode 1, Enable 0, Disable the default value is set by otp reset by power down or RST.

**PMIC\_POWER\_EN2**

Address: Operational Base + offset (0x00b3)

Bit	Attr	Reset Value	Description
7	RW	0x0	LDO8_EN_MASK LDO8_EN_MASK: MUST write them to "1" if want to change corresponding LDO8_EN bit, The LDO8_EN_MASK bits should be clear when LDO8_EN bits have been written.
6	RW	0x0	LDO7_EN_MASK LDO7_EN_MASK: MUST write them to "1" if want to change corresponding LDO7_EN bit, The LDO7_EN_MASK bits should be clear when LDO7_EN bits have been written.
5	RW	0x0	LDO6_EN_MASK LDO6_EN_MASK: MUST write them to "1" if want to change corresponding LDO6_EN bit, The LDO6_EN_MASK bits should be clear when LDO6_EN bits have been written.
4	RW	0x0	LDO5_EN_MASK LDO5_EN_MASK: MUST write them to "1" if want to change corresponding LDO5_EN bit, The LDO5_EN_MASK bits should be clear when LDO5_EN bits have been written.

Bit	Attr	Reset Value	Description
3	RW	OTP	LDO8_EN LDO8_EN: LDO8 enable in active mode 1, Enable 0, Disable the default value is set by otp reset by power down or RST.
2	RW	OTP	LDO7_EN LDO7_EN: LDO7 enable in active mode 1, Enable 0, Disable the default value is set by otp reset by power down or RST.
1	RW	OTP	LDO6_EN LDO6_EN: LDO6 enable in active mode 1, Enable 0, Disable the default value is set by otp reset by power down or RST.
0	RW	OTP	LDO5_EN LDO5_EN: LDO5 enable in active mode 1, Enable 0, Disable the default value is set by otp reset by power down or RST.

**PMIC\_POWER\_EN3**

Address: Operational Base + offset (0x00b4)

Bit	Attr	Reset Value	Description
7	RW	0x0	RESV RESV:Reserve
6	RW	0x0	OTG_EN_MASK OTG_EN_MASK : MUST write them to "1" if want to change corresponding OTG_EN bit, The OTG_EN_MASK bits should be clear when OTG_EN bits have been written.
5	RW	0x0	BOOST_EN_MASK BOOST_EN_MASK : MUST write them to "1" if want to change corresponding BOOST_EN bit, The BOOST_EN_MASK bits should be clear when BOOST_EN bits have been written.

Bit	Attr	Reset Value	Description
4	RW	0x0	LDO9_EN_MASK LDO9_EN_MASK: MUST write them to "1" if want to change corresponding LDO9_EN bit, The LDO9_EN_MASK bits should be clear when LDO9_EN bits have been written.
3	RW	0x0	RESV RESV: Reserve
2	RW	OTP	OTG_EN OTG_EN : OTG enable in active mode 1, Enable 0, Disable the default value is set by otp reset by power down or RST.
1	RW	OTP	BOOST_EN BOOST_EN : BOOST enable in active mode 1, Enable 0, Disable the default value is set by otp reset by power down or RST.
0	RW	OTP	LDO9_EN LDO9_EN: LDO9 enable in active mode 1, Enable 0, Disable the default value is set by otp reset by power down or RST.

**PMIC\_POWER\_SLP\_EN0**

Address: Operational Base + offset (0x00b5)

Bit	Attr	Reset Value	Description
7	RW	0x0	RESV RESV:Reserve
6	RW	OTP	OTG_SLP_EN OTG_SLP_EN: OTG enable in SLEEP mode 1, Enable 0, Disable the default value is set by otp reset by power down or RST.
5	RW	OTP	BOOST_SLP_EN BOOST_SLP_EN: BOOST enable in SLEEP mode 1, Enable 0, Disable the default value is set by otp reset by power down or RST.

Bit	Attr	Reset Value	Description
4	RW	OTP	LDO9_SLP_EN LDO9_SLP_EN: LDO9 enable in SLEEP mode 1, Enable 0, Disable the default value is set by otp reset by power down or RST.
3	RW	OTP	BUCK4_SLP_EN BUCK4_SLP_EN: BUCK4 enable in SLEEP mode 1, Enable 0, Disable the default value is set by otp reset by power down or RST.
2	RW	OTP	BUCK3_SLP_EN BUCK3_SLP_EN: BUCK3 enable in SLEEP mode 1, Enable 0, Disable the default value is set by otp reset by power down or RST.
1	RW	OTP	BUCK2_SLP_EN BUCK2_SLP_EN: BUCK2 enable in SLEEP mode 1, Enable 0, Disable the default value is set by otp reset by power down or RST.
0	RW	OTP	BUCK1_SLP_EN BUCK1_SLP_EN: BUCK1 enable in SLEEP mode 1, Enable 0, Disable the default value is set by otp reset by power down or RST.

**PMIC\_POWER\_SLP\_EN1**

Address: Operational Base + offset (0x00b6)

Bit	Attr	Reset Value	Description
7	RW	OTP	LDO8_SLP_EN LDO8_SLP_EN: LDO8 enable in SLEEP mode 1, Enable 0, Disable the default value is set by otp reset by power down or RST.

Bit	Attr	Reset Value	Description
6	RW	OTP	LDO7_SLP_EN LDO7_SLP_EN: LDO7 enable in SLEEP mode 1, Enable 0, Disable the default value is set by otp reset by power down or RST.
5	RW	OTP	LDO6_SLP_EN LDO6_SLP_EN: LDO6 enable in SLEEP mode 1, Enable 0, Disable the default value is set by otp reset by power down or RST.
4	RW	OTP	LDO5_SLP_EN LDO5_SLP_EN: LDO5 enable in SLEEP mode 1, Enable 0, Disable the default value is set by otp reset by power down or RST.
3	RW	OTP	LDO4_SLP_EN LDO4_SLP_EN: LDO4 enable in SLEEP mode 1, Enable 0, Disable the default value is set by otp reset by power down or RST.
2	RW	OTP	LDO3_SLP_EN LDO3_SLP_EN: LDO3 enable in SLEEP mode 1, Enable 0, Disable the default value is set by otp reset by power down or RST.
1	RW	OTP	LDO2_SLP_EN LDO2_SLP_EN: LDO2 enable in SLEEP mode 1, Enable 0, Disable the default value is set by otp reset by power down or RST.
0	RW	OTP	LDO1_SLP_EN LDO1_SLP_EN: LDO1 enable in SLEEP mode 1, Enable 0, Disable the default value is set by otp reset by power down or RST.

**PMIC\_POWER\_DISCHRG\_EN0**

Address: Operational Base + offset (0x00b7)

Bit	Attr	Reset Value	Description
7	RW	0x1	RESV RESV:Reserve
6	RW	0x1	OTG_DISCHG_EN OTG_DISCHG_EN: OTG discharge enable when the channel is off 0: Disable 1:enable
5	RW	0x1	RESV RESV:Reserve
4	RW	0x1	LDO9_DISCHG_EN LDO9_DISCHG_EN: LDO9 discharge enable when the channel is off 0: Disable 1:enable
3	RW	0x1	BUCK4_DISCHG_EN BUCK4_DISCHG_EN: BUCK4 discharge enable when the channel is off 0: Disable 1:enable
2	RW	0x1	BUCK3_DISCHG_EN BUCK3_DISCHG_EN: BUCK3 discharge enable when the channel is off 0: Disable 1:enable
1	RW	0x1	BUCK2_DISCHG_EN BUCK2_DISCHG_EN: BUCK2 discharge enable when the channel is off 0: Disable 1:enable
0	RW	0x1	BUCK1_DISCHG_EN BUCK1_DISCHG_EN: BUCK1 discharge enable when the channel is off 0: Disable 1:enable

**PMIC\_POWER\_DISCHRG\_EN1**

Address: Operational Base + offset (0x00b8)

Bit	Attr	Reset Value	Description
7	RW	0x1	LDO8_DISCHG_EN LDO8_DISCHG_EN: LDO8 discharge enable when the channel is off 0: Disable 1:enable:
6	RW	0x1	LDO7_DISCHG_EN LDO7_DISCHG_EN: LDO7 discharge enable when the channel is off 0: Disable 1:enable:
5	RW	0x1	LDO6_DISCHG_EN LDO6_DISCHG_EN: LDO6 discharge enable when the channel is off 0: Disable 1:enable:

Bit	Attr	Reset Value	Description
4	RW	0x1	LDO5_DISCHG_EN LDO5_DISCHG_EN: LDO5 discharge enable when the channel is off 0: Disable 1:enable:
3	RW	0x1	LDO4_DISCHG_EN LDO4_DISCHG_EN: LDO4 discharge enable when the channel is off 0: Disable 1:enable:
2	RW	0x1	LDO3_DISCHG_EN LDO3_DISCHG_EN: LDO3 discharge enable when the channel is off 0: Disable 1:enable:
1	RW	0x1	LDO2_DISCHG_EN LDO2_DISCHG_EN: LDO2 discharge enable when the channel is off 0: Disable 1:enable:
0	RW	0x1	LDO1_DISCHG_EN LDO1_DISCHG_EN: LDO1 discharge enable when the channel is off 0: Disable 1:enable

**PMIC\_POWER\_CONFIG**

Address: Operational Base + offset (0x00b9)

Bit	Attr	Reset Value	Description
7	RW	0x0	LDO_SLP_LP_EN LDO_SLP_LP_EN: Low power function enable bit of LDO 0: disable 1:enable
6	RW	0x0	BUCK3_FB_RES BUCK3_FB_RES: BUCK3 feedback select 0: select external feedback resistor; 1: select internal feedback resistor
5	RW	0x0	BUCK_3VLDO_BYPASS_EN BUCK_3VLDO_BYPASS_EN: 1:3V LDO disable and short to VDD enable bit 0: disable 1:enable
4	RW	0x0	BUCK_3VLDO_LP_EN BUCK_3VLDO_LP_EN: Low power function enable bit of 3VLDO 0: disable 1:enable
3	RW	0x0	BUCK4_LP_EN BUCK4_LP_EN: Low power function enable bit of BUCK4 0: disable 1:enable

Bit	Attr	Reset Value	Description
2	RW	0x0	BUCK3_LP_EN BUCK3_LP_EN: Low power function enable bit of BUCK3 0: disable 1:enable
1	RW	0x0	BUCK2_LP_EN BUCK2_LP_EN: Low power function enable bit of BUCK2 0: disable 1:enable
0	RW	0x0	BUCK1_LP_EN BUCK1_LP_EN: Low power function enable bit of BUCK1 0: disable 1:enable

**PMIC\_BUCK1\_CONFIG**

Address: Operational Base + offset (0x00ba)

Bit	Attr	Reset Value	Description
7:6	RW	0x1	BUCK1_RATE BUCK1_RATE<1:0>: BUCK1 voltage change rate after DVS 00: 3mV/uS; 01: 6.3mV/uS; 10:12.5mV/uS; 11: 25mV/uS reset by power down or RST.
5:3	RW	0x4	BUCK1_ILPK BUCK1_ILPK<2:0>: BUCK1 peak current limit select, MUST linkage adjustment with the BUCK1_ILVL<2:0>(write the same code) 000:2A 010:2.25A 010:2.5A 011:2.75A 100:3A 101:3.25A 110:3.5A 111:3.75A reset by power down or RST.
2:0	RW	0x4	BUCK1_ILVL BUCK1_ILVL<2:0>: BUCK1 valley current limit select, linkage adjustment with the BUCK1_ILPK<2:0>(write the same code) 000:2A 010:2.25A 010:2.5A 011:2.75A 100:3A 101:3.25A 110:3.5A 111:3.75A reset by power down or RST.

**PMIC\_BUCK1\_ON\_VSEL**

Address: Operational Base + offset (0x00bb)

Bit	Attr	Reset Value	Description
7	RW	0x0	BUCK1_ON_FPWM BUCK1_ON_FPWM: BUCK1 Forced PWM mode selection 1, Forced PWM mode in active mode; 0, PWM/PFM auto change mode reset by power down or RST.
6:0	RW	OTP	BUCK1_ON_VSEL BUCK1_ON_VSEL<6:0>: BUCK1 active mode voltage select 0000000:0.5V 0000001:0.5125V 0000010:0.525V ... 1010000:1.5V 1010001:1.6V 1010010:1.7V ... 1011000:2.3V 1011001~1111111:2.4V the default value is set by otp reset by power down or RST.

**PMIC\_BUCK1\_SLP\_VSEL**

Address: Operational Base + offset (0x00bc)

Bit	Attr	Reset Value	Description
7	RW	0x0	BUCK1_SLP_FPWM BUCK1_SLP_FPWM: 1, Forced PWM mode in sleep mode. 0, PWM/PFM auto change mode. reset by power down or RST.
6:0	RW	OTP	BUCK1_SLP_VSEL BUCK1_SLP_VSEL<6:0>: BUCK1 SLEEP mode voltage select 0000000:0.5V 0000001:0.5125V 0000010:0.525V ... 1010000:1.5V 1010001:1.6V 1010010:1.7V ... 1011000:2.3V 1011001~1111111:2.4V the default value is set byotp reset by power down or RST.

**PMIC\_BUCK2\_CONFIG**

Address: Operational Base + offset (0x00bd)

Bit	Attr	Reset Value	Description
7:6	RW	0x1	BUCK2_RATE BUCK2_RATE<1:0>: BUCK2 voltage change rate after DVS 00: 3mV/uS; 01: 6.3mV/uS; 10:12.5mV/uS; 11: 25mV/uS reset by power down or RST.
5:3	RW	0x4	BUCK2_ILPK BUCK2_ILPK<2:0>: BUCK2 peak current limit select, MUST linkage adjustment with the BUCK2_ILVL<2:0>(write the same code) 000:2A 010:2.25A 010:2.5A 011:2.75A 100:3A 101:3.25A 110:3.5A 111:3.75A reset by power down or RST.
2:0	RW	0x4	BUCK2_ILVL BUCK2_ILVL<2:0>: BUCK2 valley current limit select, linkage adjustment with the BUCK2_ILPK<2:0>(write the same code) 000:2A 010:2.25A 010:2.5A 011:2.75A 100:3A 101:3.25A 110:3.5A 111:3.75A reset by power down or RST.

**PMIC\_BUCK2\_ON\_VSEL**

Address: Operational Base + offset (0x00be)

Bit	Attr	Reset Value	Description
7	RW	0x0	BUCK2_ON_FPWM BUCK2_ON_FPWM: BUCK2 Forced PWM mode selection 1, Forced PWM mode in active mode; 0, PWM/PFM auto change mode reset by power down or RST.

Bit	Attr	Reset Value	Description
6:0	RW	OTP	BUCK2_ON_VSEL BUCK2_ON_VSEL<6:0>: BUCK2 active mode voltage select 0000000:0.5V 0000001:0.5125V 0000010:0.525V ... 1010000:1.5V 1010001:1.6V 1010010:1.7V ... 1011000:2.3V 1011001~1111111:2.4V the default value is set by otp reset by power down or RST.

**PMIC\_BUCK2\_SLP\_VSEL**

Address: Operational Base + offset (0x00bf)

Bit	Attr	Reset Value	Description
7	RW	0x0	BUCK2_SLP_FPWM BUCK2_SLP_FPWM: 1, Forced PWM mode in sleep mode. 0, PWM/PFM auto change mode. reset by power down or RST.
6:0	RW	OTP	BUCK2_SLP_VSEL BUCK2_SLP_VSEL<6:0>: BUCK2 SLEEP mode voltage select 0000000:0.5V 0000001:0.5125V 0000010:0.525V ... 1010000:1.5V 1010001:1.6V 1010010:1.7V ... 1011000:2.3V 1011001~1111111:2.4V the default value is set by otp reset by power down or RST.

**PMIC\_BUCK3\_CONFIG**

Address: Operational Base + offset (0x00c0)

Bit	Attr	Reset Value	Description
7:6	RW	0x1	BUCK3_RATE BUCK3_RATE<1:0>: BUCK3 voltage change rate after DVS 00: 3mV/uS; 01: 6.3mV/uS; 10:12.5mV/uS; 11: 25mV/uS reset by power down or RST.
5:3	RW	0x4	BUCK3_ILPK BUCK3_ILPK<2:0>: BUCK3 peak current limit select, MUST linkage adjustment with the BUCK3_ILVL<2:0>(write the same code) 000:1A 010:1.25A 010:1.5A 011:1.75A 100:2A 101:2.25A 110:2.5A 111:2.75A reset by power down or RST.
2:0	RW	0x4	BUCK3_ILVL BUCK3_ILVL<2:0>: BUCK3 valley current limit select, linkage adjustment with the BUCK3_ILPK<2:0>(write the same code) 000:1A 010:1.25A 010:1.5A 011:1.75A 100:2A 101:2.25A 110:2.5A 111:2.75A reset by power down or RST.

**PMIC\_BUCK3\_ON\_VSEL**

Address: Operational Base + offset (0x00c1)

Bit	Attr	Reset Value	Description
7	RW	0x0	BUCK3_ON_FPWM BUCK3_ON_FPWM: BUCK3 Forced PWM mode selection 1, Forced PWM mode in active mode; 0, PWM/PFM auto change mode reset by power down or RST.
6:0	RW	OTP	BUCK3_ON_VSEL BUCK3_ON_VSEL<6:0>: BUCK3 active mode voltage select 0000000:0.5V 0000001:0.5125V 0000010:0.525V ... 1010000:1.5V 1010001:1.6V 1010010:1.7V ... 1011000:2.3V 1011001~1111111:2.4V the default value is set by otp reset by power down or RST.

**PMIC\_BUCK3\_SLP\_VSEL**

Address: Operational Base + offset (0x00c2)

Bit	Attr	Reset Value	Description
7	RW	0x0	BUCK3_SLP_FPWM BUCK3_SLP_FPWM: 1, Forced PWM mode in sleep mode. 0, PWM/PFM auto change mode. reset by power down or RST.
6:0	RW	OTP	BUCK3_SLP_VSEL BUCK3_SLP_VSEL<6:0>: BUCK3 SLEEP mode voltage select 0000000:0.5V 0000001:0.5125V 0000010:0.525V ... 1010000:1.5V 1010001:1.6V 1010010:1.7V ... 1011000:2.3V 1011001~1111111:2.4V the default value is set by otp reset by power down or RST.

**PMIC\_BUCK4\_CONFIG**

Address: Operational Base + offset (0x00c3)

Bit	Attr	Reset Value	Description
7:6	RW	0x1	BUCK4_RATE BUCK4_RATE<1:0>: BUCK4 voltage change rate after DVS 00: 3mV/uS; 01: 6.3mV/uS; 10:12.5mV/uS; 11: 25mV/uS reset by power down or RST.
5:3	RW	0x4	BUCK4_ILPK BUCK4_ILPK<2:0>: BUCK4 peak current limit select, MUST linkage adjustment with the BUCK4_ILVL<2:0>(write the same code) 000:1A 010:1.25A 010:1.5A 011:1.75A 100:2A 101:2.25A 110:2.5A 111:2.75A reset by power down or RST.

Bit	Attr	Reset Value	Description
2:0	RW	0x4	BUCK4_ILVL BUCK4_ILVL<2:0>: BUCK4 valley current limit select, linkage adjustment with the BUCK4_ILPK<2:0>(write the same code) 000:1A 010:1.25A 010:1.5A 011:1.75A 100:2A 101:2.25A 110:2.5A 111:2.75A reset by power down or RST.

**PMIC\_BUCK4\_ON\_VSEL**

Address: Operational Base + offset (0x00c4)

Bit	Attr	Reset Value	Description
7	RW	0x0	BUCK4_ON_FPWM BUCK4_ON_FPWM: BUCK4 Forced PWM mode selection 1, Forced PWM mode in active mode; 0, PWM/PFM auto change mode reset by power down or RST.
6:0	RW	OTP	BUCK4_ON_VSEL BUCK4_ON_VSEL<6:0>: BUCK4 active mode voltage select 0000000:0.5V 0000001:0.5125V 0000010:0.525V ... 1010000:1.5V 1010001:1.6V 1010010:1.7V ... 1100011~1111111:3.4V the default value is set by otp reset by power down or RST.

**PMIC\_BUCK4\_SLP\_VSEL**

Address: Operational Base + offset (0x00c5)

Bit	Attr	Reset Value	Description
7	RW	0x0	BUCK4_SLP_FPWM BUCK4_SLP_FPWM: 1, Forced PWM mode in sleep mode. 0, PWM/PFM auto change mode. reset by power down or RST.

Bit	Attr	Reset Value	Description
6:0	RW	OTP	BUCK4_SLP_VSEL BUCK4_SLP_VSEL<6:0>: BUCK4 SLEEP mode voltage select 0000000:0.5V 0000001:0.5125V 0000010:0.525V ... 1010000:1.5V 1010001:1.6V 1010010:1.7V ... 1100011~1111111:3.4V the default value is set by otp reset by power down or RST.

**PMIC\_BUCK4\_CMIN**

Address: Operational Base + offset (0x00c6)

Bit	Attr	Reset Value	Description
7	RW	0x0	SYSUV_DLY_SEL SYSUV_DLY_SEL: Sys under voltage delay time selection 0: 5uS 1:50uS
6	RW	0x0	LDO3_UVSD_EN LDO3_UVSD_EN: SYSUV to shutdown the LDO3 function 0:Disable 1:enable
5	RW	0x0	SYSUV_TRIG_RESETB_EN SYSUV_TRIG_RESETB_EN:SYSUV to trigger restart the PMIC function 0:Disable 1:enable
4	RW	0x0	I2S_RX_MST I2S RX module as master mode(1)/slave mode(0) reset by power down or RST.
3	RW	0x0	BUCK4_CMIN_EN BUCK4_CMIN_EN:BUCK4 min Current limit enable 1, Enable 0, Disable reset by power down or RST.

Bit	Attr	Reset Value	Description
2:1	RW	0x2	BUCK4_CMIN_SEL BUCK4_CMIN_SEL<2:1>: BUCK4 min Current limit select reset by power down or RST. 00:200mA 01:300mA 10:400mA 11:500mA
0	RW	0x0	RESV RESV: Reserve

**PMIC\_LDO1\_ON\_VSEL**

Address: Operational Base + offset (0x00cc)

Bit	Attr	Reset Value	Description
7	RW	0x0	LDO1_IMAX LDO1_IMAX:LDO1 current limit setting 0: normal, 1: 130% of nominal value reset by power down or RST.
6:0	RW	OTP	LDO1_ON_VSEL LDO1_ON_VSEL: LDO1 active mode voltage select, 0.6V~3.4V(step=25mV) 0000000:0.6V 0000001:0.625V 0000010:0.65V ... 1110000~1111111:3.4V the default value is set by otp reset by power down or RST.

**PMIC\_LDO1\_SLP\_VSEL**

Address: Operational Base + offset (0x00cd)

Bit	Attr	Reset Value	Description
7	RW	0x0	RESV RESV:Reserve
6:0	RW	OTP	LDO1_SLP_VSEL LDO1_SLP_VSEL:LDO1 SLEEP mode voltage select, 0.6V~3.4V(step=25mV) 0000000:0.6V 0000001:0.625V 0000010:0.65V ... 1110000~1111111:3.4V the default value is set by otp reset by power down or RST.

**PMIC\_LDO2\_ON\_VSEL**

Address: Operational Base + offset (0x00ce)

Bit	Attr	Reset Value	Description
7	RW	0x0	LDO2_IMAX LDO2_IMAX:LDO2 current limit setting 0: normal, 1: 130% of nominal value reset by power down or RST.
6:0	RW	OTP	LDO2_ON_VSEL LDO2_ON_VSEL: LDO2 active mode voltage select, 0.6V~3.4V(step=25mV) 0000000:0.6V 0000001:0.625V 0000010:0.65V ... 1110000~1111111:3.4V the default value is set by otp reset by power down or RST.

**PMIC\_LDO2\_SLP\_VSEL**

Address: Operational Base + offset (0x00cf)

Bit	Attr	Reset Value	Description
7	RW	0x0	RESV RESV:Reserve
6:0	RW	OTP	LDO2_SLP_VSEL LDO2_SLP_VSEL:LDO2 SLEEP mode voltage select, 0.6V~3.4V(step=25mV) 0000000:0.6V 0000001:0.625V 0000010:0.65V ... 1110000~1111111:3.4V the default value is set by otp reset by power down or RST.

**PMIC\_LDO3\_ON\_VSEL**

Address: Operational Base + offset (0x00d0)

Bit	Attr	Reset Value	Description
7	RW	0x0	LDO3_IMAX LDO3_IMAX:LDO3 current limit setting 0: normal, 1: 130% of nominal value reset by power down or RST.

Bit	Attr	Reset Value	Description
6:0	RW	OTP	LDO3_ON_VSEL LDO3_ON_VSEL: LDO3 active mode voltage select, 0.6V~3.4V(step=25mV) 0000000:0.6V 0000001:0.625V 0000010:0.65V ... 1110000~1111111:3.4V the default value is set by otp reset by power down or RST.

**PMIC\_LDO3\_SLP\_VSEL**

Address: Operational Base + offset (0x00d1)

Bit	Attr	Reset Value	Description
7	RW	0x0	RESV RESV:Reserve
6:0	RW	OTP	LDO3_SLP_VSEL LDO3_SLP_VSEL:LDO3 SLEEP mode voltage select, 0.6V~3.4V(step=25mV) 0000000:0.6V 0000001:0.625V 0000010:0.65V ... 1110000~1111111:3.4V the default value is set by otp reset by power down or RST.

**PMIC\_LDO4\_ON\_VSEL**

Address: Operational Base + offset (0x00d2)

Bit	Attr	Reset Value	Description
7	RW	0x0	LDO4_IMAX LDO4_IMAX:LDO4 current limit setting 0: normal, 1: 130% of nominal value reset by power down or RST.

Bit	Attr	Reset Value	Description
6:0	RW	OTP	LDO4_ON_VSEL LDO4_ON_VSEL: LDO4 active mode voltage select, 0.6V~3.4V(step=25mV) 0000000:0.6V 0000001:0.625V 0000010:0.65V ... 1110000~1111111:3.4V the default value is set by otp reset by power down or RST.

**PMIC\_LDO4\_SLP\_VSEL**

Address: Operational Base + offset (0x00d3)

Bit	Attr	Reset Value	Description
7	RW	0x0	RESV RESV:Reserve
6:0	RW	OTP	LDO4_SLP_VSEL LDO4_SLP_VSEL:LDO4 SLEEP mode voltage select, 0.6V~3.4V(step=25mV) 0000000:0.6V 0000001:0.625V 0000010:0.65V ... 1110000~1111111:3.4V the default value is set by otp reset by power down or RST.

**PMIC\_LDO5\_ON\_VSEL**

Address: Operational Base + offset (0x00d4)

Bit	Attr	Reset Value	Description
7	RW	0x0	LDO5_IMAX LDO5_IMAX:LDO5current limit setting 0: normal, 1: 130% of nominal value reset by power down or RST.

Bit	Attr	Reset Value	Description
6:0	RW	OTP	LDO5_ON_VSEL LDO5_ON_VSEL: LDO5 active mode voltage select, 0.6V~3.4V(step=25mV) 0000000:0.6V 0000001:0.625V 0000010:0.65V ... 1110000~1111111:3.4V the default value is set by otp reset by power down or RST.

**PMIC\_LDO5\_SLP\_VSEL**

Address: Operational Base + offset (0x00d5)

Bit	Attr	Reset Value	Description
7	RW	0x0	RESV RESV:Reserve
6:0	RW	OTP	LDO5_SLP_VSEL LDO5_SLP_VSEL:LDO5 SLEEP mode voltage select, 0.6V~3.4V(step=25mV) 0000000:0.6V 0000001:0.625V 0000010:0.65V ... 1110000~1111111:3.4V the default value is set by otp reset by power down or RST.

**PMIC\_LDO6\_ON\_VSEL**

Address: Operational Base + offset (0x00d6)

Bit	Attr	Reset Value	Description
7	RW	0x0	LDO6_IMAX LDO6_IMAX:LDO6 current limit setting 0: normal, 1: 130% of nominal value reset by power down or RST.

Bit	Attr	Reset Value	Description
6:0	RW	OTP	LDO6_ON_VSEL LDO6_ON_VSEL: LDO6 active mode voltage select, 0.6V~3.4V(step=25mV) 0000000:0.6V 0000001:0.625V 0000010:0.65V ... 1110000~1111111:3.4V the default value is set by otp reset by power down or RST.

**PMIC\_LDO6\_SLP\_VSEL**

Address: Operational Base + offset (0x00d7)

Bit	Attr	Reset Value	Description
7	RW	0x0	RESV RESV:Reserve
6:0	RW	OTP	LDO6_SLP_VSEL LDO6_SLP_VSEL:LDO6 SLEEP mode voltage select, 0.6V~3.4V(step=25mV) 0000000:0.6V 0000001:0.625V 0000010:0.65V ... 1110000~1111111:3.4V the default value is set by otp reset by power down or RST.

**PMIC\_LDO7\_ON\_VSEL**

Address: Operational Base + offset (0x00d8)

Bit	Attr	Reset Value	Description
7	RW	0x0	LDO7_IMAX Field0000 Abstract LDO7_IMAX:LDO7 current limit setting 0: normal, 1: 130% of nominal value reset by power down or RST.

Bit	Attr	Reset Value	Description
6:0	RW	OTP	LDO7_ON_VSEL LDO7_ON_VSEL: LDO7 active mode voltage select, 0.6V~3.4V(step=25mV) 0000000:0.6V 0000001:0.625V 0000010:0.65V ... 1110000~1111111:3.4V the default value is set by otp reset by power down or RST.

**PMIC\_LDO7\_SLP\_VSEL**

Address: Operational Base + offset (0x00d9)

Bit	Attr	Reset Value	Description
7	RW	0x0	RESV RESV:Reserve
6:0	RW	OTP	LDO7_SLP_VSEL LDO7_SLP_VSEL:LDO7 SLEEP mode voltage select, 0.6V~3.4V(step=25mV) 0000000:0.6V 0000001:0.625V 0000010:0.65V ... 1110000~1111111:3.4V the default value is set by otp reset by power down or RST.

**PMIC\_LDO8\_ON\_VSEL**

Address: Operational Base + offset (0x00da)

Bit	Attr	Reset Value	Description
7	RW	0x0	LDO8_IMAX LDO8_IMAX:LDO8 current limit setting 0: normal, 1: 130% of nominal value reset by power down or RST.

Bit	Attr	Reset Value	Description
6:0	RW	OTP	LDO8_ON_VSEL Field0000 Abstract LDO8_ON_VSEL: LDO8 active mode voltage select, 0.6V~3.4V(step=25mV) 0000000:0.6V 0000001:0.625V 0000010:0.65V ... 1110000~1111111:3.4V the default value is set by otp reset by power down or RST.

**PMIC\_LDO8\_SLP\_VSEL**

Address: Operational Base + offset (0x00db)

Bit	Attr	Reset Value	Description
7	RW	0x0	RESV RESV:Reserve
6:0	RW	OTP	LDO8_SLP_VSEL LDO8_SLP_VSEL:LDO8 SLEEP mode voltage select, 0.6V~3.4V(step=25mV) 0000000:0.6V 0000001:0.625V 0000010:0.65V ... 1110000~1111111:3.4V the default value is set by otp reset by power down or RST.

**PMIC\_LDO9\_ON\_VSEL**

Address: Operational Base + offset (0x00dc)

Bit	Attr	Reset Value	Description
7	RW	0x0	LDO9_IMAX LDO9_IMAX:LDO9 current limit setting 0: normal, 1: 130% of nominal value reset by power down or RST.

Bit	Attr	Reset Value	Description
6:0	RW	OTP	LDO9_ON_VSEL LDO9_ON_VSEL: LDO9 active mode voltage select, 0.6V~3.4V(step=25mV) 0000000:0.6V 0000001:0.625V 0000010:0.65V ... 1110000~1111111:3.4V the default value is set by otp reset by power down or RST.

**PMIC\_LDO9\_SLP\_VSEL**

Address: Operational Base + offset (0x00dd)

Bit	Attr	Reset Value	Description
7	RW	0x0	RESV RESV:Reserve
6:0	RW	OTP	LDO9_SLP_VSEL LDO9_SLP_VSEL:LDO9 SLEEP mode voltage select, 0.6V~3.4V(step=25mV) 0000000:0.6V 0000001:0.625V 0000010:0.65V ... 1110000~1111111:3.4V the default value is set by otp reset by power down or RST.

**PMIC\_BOOST\_OTG\_CONFIG0**

Address: Operational Base + offset (0x00de)

Bit	Attr	Reset Value	Description
7:6	RW	0x0	OTG_ILIM OTG_ILIM: OTG current limit selection 00: 1A 01:1.5A 10:1.8A 11: 2.1A reset by power down or RST.
5	RW	0x0	RESV Reserved
4:3	RW	0x1	BOOST_ILMAX BOOST_ILMAX:BOOST inductor peak current setting 00:2.5A 01:3A 10:4A 11:5A reset by power down or RST.

Bit	Attr	Reset Value	Description
2:0	RW	OTP	BOOST_ON_VSEL BOOST_ON_VSEL:BOOST active mode voltage select. 000:4.7V 001:4.8V 010:4.9V 011:5V 100:5.1V 101:5.2V 110:5.3V 111:5.4V the default value is set by otp reset by power down or RST.

**PMIC\_BOOST\_CONFIG1**

Address: Operational Base + offset (0x00df)

Bit	Attr	Reset Value	Description
7:5	RW	0x1	RESV Reserved
4:3	RW	0x2	BOOST_ZCD BOOST_ZCD<1:0>: BOOSTzero current detection select 00:50mA 01: 100mA 10:150mA 11:200mA
2:0	RW	OTP	BOOST_SLP_VSEL BOOST_SLP_VSEL:BOOST SLEEP mode voltage select. 000: 4.7V; 001: 4.8V; 010: 4.9V; 011: 5.0V 100: 5.1V; 101: 5.2V; 110: 5.3V; 111: 5.4V the default value is set by otp reset by power down or RST.

**PMIC\_CHRG\_OUT**

Address: Operational Base + offset (0x00e4)

Bit	Attr	Reset Value	Description
7	RW	0x1	POWERPATH_EN PWOERPATH_EN: PWOERPATH enable signal 0:disable 1: enable
6:4	RW	0x2	CHRG_VOL_SEL CHRG_VOL_SEL: charger voltage selection 000:4.1V 001:4.15V 010:4.2V 011:4.25V 100:4.3V 101:4.35; 110:4.4V; 111:4.45V
3	RW	0x0	CHRG_CT_EN CHRG_CT_EN:Charger Thermal foldback enable 0:disable 1:enable
2:0	RW	0x2	CHRG_CUR_SEL CHRG_CUR_SEL: charger current selection 000:1A 001:1.5A 010:2A 011:2.5A 100:2.75A 101:3A 110:3.5A 111:0.5A

**PMIC\_CHRG\_IN**

Address: Operational Base + offset (0x00e5)

Bit	Attr	Reset Value	Description
7	RW	0x1	USB_VLIM_EN USB_VLIM_EN: whether the USB input voltage limit function is enable 0:disable 1: enable
6:4	RW	0x4	USB_VLIM_SEL USB_VLIM_SEL: the USB input voltage limit selection 000:4.0V 001:4.1V 010:4.2V 011:4.3V 100:4.4V 101:4.5V 110:4.6V 111:4.7V
3	RW	0x1	USB_ILIM_EN USB_ILIM_EN: whether the USB input current limit function is enable 0:disable 1: enable
2:0	RW	OTP	USB_ILIM_SEL USB_ILIM_SEL: the USB input average current limit selection 000:0.45 001:0.08A 010:0.85A 011:1.5A 100:1.75A 101:2A 110:2.5A 111:3A the default value is set by OTP.

**PMIC\_CHRG\_TERM**

Address: Operational Base + offset (0x00e6)

Bit	Attr	Reset Value	Description
7	RW	0x1	SYS_CAN_SD SYS_CAN_SD:whether the system voltage can be shutdown in PWR_off mode 0:not 1:yes
6	RW	0x1	CHRG_EN CHRG_EN: enable charger 0:disable 1:enable reset by power down or RST.
5:4	RW	0x0	RESV RESV:Reserve
3	RW	0x0	BAT_OVP_EN BAT_OVP_EN: BAT OVP ENABLE 0:disable 1: enable
2	RW	0x1	CHRG_TERM_ANA_DIG CHRG_TERM_ANA_DIG:charger termination adjustment selection 0: analog 1:digital

Bit	Attr	Reset Value	Description
1:0	RW	0x1	CHRG_TERM_ANA_SEL CHRG_TERM_ANA_SEL: analog charging termination selection 00:150mA 01:200mA 10:300mA 11:400mA

**PMIC\_CHRG\_TERM\_DIG**

Address: Operational Base + offset (0x00e7)

Bit	Attr	Reset Value	Description
7:0	RW	0x20	CHRG_TERM_DIG CHRG_TERM_DIG: CHRG TERM DIGITAL CURRENT SELLECT Compared with BAT_CUR<12:5>

**PMIC\_BAT\_HTS\_TS**

Address: Operational Base + offset (0x00e8)

Bit	Attr	Reset Value	Description
7:0	RW	0x00	BAT_HTS_TS BAT_HTS_TS: battery high temperature protection in TS according to ADC SPEC, high 8bit of ADC value, the external resistor is negative temperature coefficient, so BAT_HTS_TS<BAT_LTS_TS

**PMIC\_BAT\_LTS\_TS**

Address: Operational Base + offset (0x00e9)

Bit	Attr	Reset Value	Description
7:0	RW	0xff	BAT_LTS_TS BAT_LTS_TS: battery low temperature protection in TS according to ADC SPEC,high 8bit of ADC value, the external resistor is negative temperature coefficient, so BAT_HTS_TS<BAT_LTS_TS

**PMIC\_CHRG\_TO**

Address: Operational Base + offset (0x00ea)

Bit	Attr	Reset Value	Description
7	RW	0x0	CHRG_TIMER_TRIKL_EN CHRG_TIMER_TRIKL_EN: trickle charging timer enable, 0:disable 1:enable
6:4	RW	0x2	CHRG_TIMER_TRIKL CHRG_TIMER_TRIKL: trickle charge timer selection 000:30min 001:45min 010:60min 011:90min 100:120min 101:150min 110:180min 111:210min
3	RW	0x0	CHRG_TIMER_CCCV_EN CHRG_TIMER_CCCV_EN: Constant current and Constant voltage charging timer enable, 0:disable 1:enable
2:0	RW	0x2	CHRG_TIMER_CCCV CHRG_TIMER_CCCV:CC CV charge timer selection 000:4h 001:5h 010:6h 011:8h 100:10h 101:12h 110:14h 111:16h

**PMIC\_CHRG\_STS**

Address: Operational Base + offset (0x00eb)

Bit	Attr	Reset Value	Description
7	RO	0x0	BAT_EXS BAT_EXS:bat exists (only writable at test mode) 0:Not exists 1:exists
6:4	RO	0x0	CHG_STS CHG_STS: charging status 000: charge off 001:dead charge 010:trickle charge 011: CC or CV charge 100:charge TERM 101:USB over voltage 110:BAT temperature error 111:BAT time error
3	RO	0x0	BAT_OVP_STS BAT_OVP_STS:BAT OVP happen, this bit will be set high.
2	RO	0x0	CHRG_IN_CLAMP CHRG_IN_CLAMP: When charger incc, incv or constant temperature happen, this bit will be set "1"

Bit	Attr	Reset Value	Description
1	RO	0x0	USB_EXS USB_EXS:USB exists (only writable at test mode) 0: Not exists, 1: exists
0	RO	0x0	USB_EFF USB_EFF:USB is effective (only writable at test mode) 0: Not effective, 1: effective

**PMIC\_BAT\_DISCHRG**

Address: Operational Base + offset (0x00ec)

Bit	Attr	Reset Value	Description
7	RW	0x0	RESV RESV:Reserve
6	RO	0x0	BAT_DIS_ILIM_STS BAT_DIS_ILIM_STS:When bat discharge current is limited, this bit will be set high.
5:4	RW	0x0	BAT_SYS_CMP_DLY BAT_SYS_CMP_DLY:bat and system comparator delay time 00:5uS 10:10uS 01:25uS 11:30uS
3	RW	0x1	BAT_DIS_ILIM_EN BAT_DIS_ILIM_EN:the bat discharger current limit function enable 0:disable 1:enable
2:0	RW	0x2	BAT_DISCHRG_ILIM BAT_DISCHRG_ILIM:battery discharge current limit 000:2A 001:2.5A 010:3A 011 3.5A 1xx:4A

**PMIC\_CHIP\_NAME**

Address: Operational Base + offset (0x00ed)

Bit	Attr	Reset Value	Description
7:0	RO	0x81	CHIP_NAME CHIP_NAME:CHIP name code<11:4>. RK817: default 81

**PMIC\_CHIP\_VER**

Address: Operational Base + offset (0x00ee)

Bit	Attr	Reset Value	Description
7:4	RO	0x7	CHIP_NAME CHIP_NAME:CHIP name code<3:0>. RK817: default 7
3:0	RO	0x2	RESV RESV: Reserve

**PMIC\_OTP\_VER**

Address: Operational Base + offset (0x00ef)

Bit	Attr	Reset Value	Description
7:6	RW	0x0	LDO1P8A_VSEL LDO1P8A_VSEL: VCC_1P8A voltage select 00: 1.8V 01: 1.6V 10: 1.9V 11:2.0V
5:4	RO	0x0	RESV RESV: Reserve
3:0	RO	OTP	OTP_VER OTP_VER: OTP revize version. default OTP.

**PMIC\_SYS\_STS**

Address: Operational Base + offset (0x00f0)

Bit	Attr	Reset Value	Description
7	RO	0x0	PWRON_STS PWRON_STS: PWRON key status 0: PWRON not press 1:PWRON button pressed reset by power down or RST
6	RO	0x0	PLUG_IN_STS PLUG_IN_STS: USB plug-in event occurs(USB voltage >3.8V after pull down 20mA current) 0: no USB plug in 1: USB plugged in
5	RO	0x0	VB_UV_STS VB_UV_STS: Battery under voltage lockout status
4	RO	0x0	VB_LO_STS VB_LO_STS: Battery low voltage status 0: VBAT>VB_LO_SEL 1: VBAT<VB_LO_SEL
3	RO	0x0	HOTDIE_STS HOTDIE_STS: Hot-die warning
2	RO	0x0	TSD_STS TSD_STS: Thermal shut down

Bit	Attr	Reset Value	Description
1	RO	0x0	BAT_HI_STS BAT_HI_STS:battery higher than USB status bit
0	RO	0x0	SYS_OV_STS SYS_OV_STS: system over voltage status bit

**PMIC\_SYS\_CFG0**

Address: Operational Base + offset (0x00f1)

Bit	Attr	Reset Value	Description
7	RW	0x1	SYS_OV_EN SYS_OV_EN: SYS over voltage function enable 0:disable 1:enable
6:4	RW	0x0	VB_UV_SEL VB_UV_SEL:SYS shut down voltage select, 2.7V~3.4V, step=100mV 000:2.7V; 001:2.8V; 010:2.9V; 011:3.0V 100:3.1V; 101:3.2V; 110:3.3V; 111:3.4V reset by power down or RST
3	RW	0x1	VB_LO_ACT VB_LO_ACT: SYS low volatge action 0: shut down system 1: insert interrupt reset by power down or RST
2:0	RW	0x4	VB_LO_SEL VB_LO_SEL: SYS low voltage threshold,2.8V~3.5V, step=100mV 000:2.8V; 001:2.9V; 010:3.0V; 011:3.1V 100:3.2V; 101:3.3V; 110:3.4V; 111:3.5V reset by power down or RST

**PMIC\_SYS\_CFG1**

Address: Operational Base + offset (0x00f2)

Bit	Attr	Reset Value	Description
7	RW	0x1	CLK32KOUT_EN CLK32KOUT_EN: CLK32K output is enable 1. enable 0. disable reset by power down or RST

Bit	Attr	Reset Value	Description
6	RW	0x0	TSD_TEMP TSD_TEMP: Thermal shutdown temperature threshold 0: 140°C; 1: 160°C reset by power down or RST
5:4	RW	0x0	HOTDIE_TEMP HOTDIE_TEMP: Hot-die temperature threshold 00:85°C 01:95°C 10:105°C 11:115°C reset by power down or RST
3	RW	0x0	SYS_OV_SD_EN SYS_OV_SD_EN: Shut down the BUCK1~4 mosfet if the SYS OV happens 0:Disable 1:Enable
2	RW	0x0	SYS_OV_SD_TIME SYS_OV_SD_TIME: SYS OV comparator delay time selection 0: 8uS 1:30uS
1	RW	0x0	USB_OV_SD_EN USB_OV_SD_EN: Shut down the charger mosfet if the USB OV happens 0:Disable 1:Enable
0	RW	0x0	USB_OV_SD_TIME USB_OV_SD_TIME: USB OV comparator delay time selection 0: 8uS 1:60uS

**PMIC\_SYS\_CFG2**

Address: Operational Base + offset (0x00f3)

Bit	Attr	Reset Value	Description
7	RW	0x0	ADC_PHASE ADC_PHASE: ADC phase select 0: normal 1: reverse
6	RW	0x1	CHRG_CLK_SEL CHRG_CLK_SEL: charger clock select 0:1Meg 1:2Meg
5	RW	0x0	HK_BG_SUP_SEL HK_BG_SUP_SEL: house keeping band gap supply select 0:VCCRTC 1: Internal LDO

Bit	Attr	Reset Value	Description
4	RW	0x0	HK_REF_RES_SEL HK_REF_RES_SEL: house keeping reference filter resistor select 0: 100% 1: 200%
3	RW	0x0	HK_REF_LP_EN HK_REF_LP_EN: house keeping reference lower power enable 1. enable 0. disable
2	RW	0x0	USB_OV_SEL USB_OV_SEL: usb over voltage threshold select 0: 6V 1: 5.8V
1	RW	0x0	SYS_UV_PRE_DLY SYS_UV_PRE_DLY: SYS under voltage delay time select 0: 1.5uS 1: 5uS
0	RW	0x0	USB_OV_DLY USB_OV_DLY: usb over voltage delay time select 0: 5uS 1: 3uS

**PMIC\_SYS\_CFG3**

Address: Operational Base + offset (0x00f4)

Bit	Attr	Reset Value	Description
7:6	RW	0x0	RST_FUN: reset function selection: 00: Restart the PMU. 01: reset DCDC and LDO. (Do not use this mode when SLEEP.) 1x: Do not use.
5	RW	0x1	SLP_POL SLP_POL: SLEEP pin polarity 0: active low 1: active high reset by power down or RST

Bit	Attr	Reset Value	Description
4:3	RW	0x0	SLP_FUN SLP_FUN: SLEEP PIN function selection: 00: not effect; 01: sleep function; 10:shutdown function; 11:restart pmu function. reset by power down or RST
2	RW	0x0	DEV_RST DEV_RST: Write 1 will 'RST' the device. Note: 'RST' is not only a reset source, but a special function defined by 'RST_FUN' reset by power down or RST
1	RW	0x0	DEV_SLP DEV_SLP: Write 1 will go to SLEEP state. reset by power down or RST
0	RW	0x0	DEV_OFF DEV_OFF: Write 1 will shutdown the device. reset by power down or RST

**PMIC\_ON\_SOURCE**

Address: Operational Base + offset (0x00f5)

Bit	Attr	Reset Value	Description
7	RO	0x0	ON_PWRON ON_PWRON: PRESS PWRON to turn on PMU reset by power down or RST, and load this bit after reset.
6	RO	0x0	ON_PLUG_IN ON_PLUG_IN:USB PLUG IN to turn on PMU reset by power down or RST
5	RO	0x0	ON_RTC ON_RTC:RTC timer to turn on PMU reset by power down or RST
4	RO	0x0	RESTART_RESETB RESTART_RESETB:PULL LOW the RESETB PIN to restart the PMU reset by power down or RST
3	RO	0x0	RESTART_PWRON_LP RESTART_PWRON_LP:Long press PWRON to restart the PMU reset by power down or RST
2	RO	0x0	RESTART_SLP RESTART_SLP:SLEEP PIN ACTIVE to restart the PMU reset by power down or RST

Bit	Attr	Reset Value	Description
1	RW	0x0	RESTART_DEV_RST RESTART_DEV_RST: I2C write DEV_RST to restart PMU reset by power down or RST
0	RO	0x0	RESV RESV: Reserve

**PMIC\_OFF\_SOURCE**

Address: Operational Base + offset (0x00f6)

Bit	Attr	Reset Value	Description
7	RO	0x0	OFF_SLP OFF_SLP: SLEEP PIN ACTIVE to turn off PMU reset by power down or RST, and load this bit after reset.
6	RO	0x0	OFF_SYS_OV OFF_SYS_OV:SYS OV to turn off PMU reset by power down or RST, and load this bit after reset.
5	RO	0x0	OFF_TSD OFF_TSD:TSD to turn off PMU reset by power down or RST, and load this bit after reset.
4	RO	0x0	OFF_VB_UV OFF_VB_UV:SYS UV to turn off PMU reset by power down or RST, and load this bit after reset.
3	RO	0x0	OFF_DEV_OFF OFF_DEV_OFF:I2C write DEV_OFF to turn off PMU reset by power down or RST, and load this bit after reset.
2	RO	0x0	OFF_PWRON_LP OFF_PWRON_LP:long press PWRON to turn off PMU reset by power down or RST, and load this bit after reset.
1	RO	0x0	OFF_USB_EFF_NOT OFF_USB_EFF_NOT: USB OV or UV to turn off PMU when BUCK MODE reset by power down or RST, and load this bit after reset.

Bit	Attr	Reset Value	Description
0	RO	0x0	OFF_VB_LO OFF_VB_LO:SYS Low (if VB_LO_ACT=0)to turn off PMU reset by power down or RST, and load this bit after reset.

**PMIC\_PWRON\_KEY**

Address: Operational Base + offset (0x00f7)

Bit	Attr	Reset Value	Description
7	RW	OTP	PWRON_ON_TIME PWRON_ON_TIME:0:500mS; 1:100mS default OTP.
6	RW	0x0	PWRON_LP_ACT PWRON_LP_ACT: PWRON long press act 0: turn off 1: turn off and then restart
5:4	RW	0x0	PWRON_LP_OFF_TIME PWRON_LP_OFF_TIME: PWRON long press time: 00: 6s, 01: 8s, 10: 10s, 11: 12s
3:2	RW	0x1	PWRON_LP_TM PWRON_LP_TM_SEL<1:0>:PWRON long press interrupt time selection: 00: 0.5S 01:1S 10:1.5S 11:2S
1:0	RW	0x2	PWRON_DB_SEL PWRON_DB_SEL<1:0>:PWRON interrupt debounce time selection: 00: 32uS 01:10mS 10:20mS 11:40mS

**PMIC\_INT\_STS0**

Address: Operational Base + offset (0x00f8)

Bit	Attr	Reset Value	Description
7	W1C	0x0	VB_LO_INT VB_LO_INT: Battery under voltage alarm event interrupt status. reset by power down or RST.
6	W1C	0x0	RTC_PERIOD_INT RTC_PERIOD_INT: RTC period event interrupt. reset by power down or RST.
5	W1C	0x0	RTC_ALARM_INT RTC_ALARM_INT: RTC alarm event interrupt. reset by power down or RST.

Bit	Attr	Reset Value	Description
4	W1C	0x0	HOTDIE_INT HOTDIE_INT: Hot die event interrupt status. reset by power down or RST.
3	W1C	0x0	PWRON_LP_INT PWRON_LP_INT: PWRON PIN long press event interrupt status. reset by power down or RST.
2	W1C	0x0	PWRON_INT PWRON_INT: PWRON event interrupt status. reset by power down or RST.
1	W1C	0x0	PWRON_RISE_INT PWRON_RISE_INT: PWRON rising event interrupt reset by power down or RST.
0	W1C	0x0	PWRON_FALL_INT PWRON_FALL_INT: PWRON falling event interrupt reset by power down or RST.

**PMIC\_INT\_MSK0**

Address: Operational Base + offset (0x00f9)

Bit	Attr	Reset Value	Description
7	RW	0x0	VB_LO_IM VB_LO_IM: Battery under voltage alarm event interrupt mask reset by power down or RST.
6	RW	0x0	RTC_PERIOD_IM RTC_PERIOD_IM: RTC period event interrupt mask reset by power down or RST.
5	RW	0x0	RTC_ALARM_IM RTC_ALARM_IM: RTC alarm event interrupt mask reset by power down or RST.
4	RW	0x0	HOTDIE_IM HOTDIE_IM: Hot die event interrupt mask reset by power down or RST.
3	RW	0x0	PWRON_LP_IM PWRON_LP_IM: PWRON PIN long press event interrupt mask reset by power down or RST.

Bit	Attr	Reset Value	Description
2	RW	0x0	PWRON_IM PWRON_IM:PWRON event interrupt mask reset by power down or RST.
1	RW	0x0	PWRON_RISE_INT_IM PWRON_RISE_INT_IM:PWRON rising event interrupt mask reset by power down or RST.
0	RW	0x0	PWRON_FALL_INT_IM PWRON_FALL_INT_IM:PWRON falling event interrupt mask reset by power down or RST.

**PMIC\_INT\_STS1**

Address: Operational Base + offset (0x00fa)

Bit	Attr	Reset Value	Description
7	W1C	0x0	BAT_DIS_ILIM_INT BAT_DIS_ILIM_INT:Battery discharge current over the setting value event interrupt. reset by power down or RST.
6	W1C	0x0	CHRG_IN_CLMP_INT CHRG_IN_CLMP_INT:Charger USB input current limit or USB input voltage limit or chip constant temperature event interrupt (write 1 clear or POWERPATH_EN=0 clear)
5	W1C	0x0	USB_OV_INT USB_OV_INT:USB over voltage event interrupt (write 1 clear or POWERPATH_EN=0 clear)
4	W1C	0x0	CHRG_TS_INT CHRG_TS_INT:Charger TS over or under temperature event interrupt (write 1 clear or POWERPATH_EN=0 clear)
3	W1C	0x0	CHRG_TIME_INT CHRG_TIME_INT:Charger time error event interrupt (write 1 clear or POWERPATH_EN=0 clear)
2	W1C	0x0	CHRG_TERM__INT CHRG_TERM__INT:Charger finished event interrupt (write 1 clear or POWERPATH_EN=0 clear)

Bit	Attr	Reset Value	Description
1	W1C	0x0	PLUG_OUT_INT PLUG_OUT_INT: USB plug out event interrupt reset by power down or RST.
0	W1C	0x0	PLUG_IN_INT PLUG_IN_INT: USB plug in event interrupt reset by power down or RST.

**PMIC\_INT\_MSK1**

Address: Operational Base + offset (0x00fb)

Bit	Attr	Reset Value	Description
7	RW	0x0	BAT_DIS_ILIM_INT_IM BAT_DIS_ILIM_INT_IM: Battery discharge current over the setting value event interrupt mask. reset by power down or RST.
6	RW	0x0	CHRG_IN_CLMP_INT_IM CHRG_IN_CLMP_INT_IM: Charger USB input current limit or USB input voltage limit or chip constant temperature event interrupt mask.
5	RW	0x0	USB_OV_INT_IM USB_OV_INT_IM: USB over voltage event interrupt mask
4	RW	0x0	CHRG_TS_INT_IM CHRG_TS_INT_IM: Charger TS over or under temperature event interrupt mask
3	RW	0x0	CHRG_TIME_INT_IM CHRG_TIME_INT_IM: Charger time error event interrupt mask
2	RW	0x0	CHRG_TERM_INT_IM CHRG_TERM_INT_IM: Charger finished event interrupt mask
1	RW	0x0	PLUG_OUT_INT_IM PLUG_OUT_INT_IM: USB plug out event interrupt mask reset by power down or RST.
0	RW	0x0	PLUG_IN_INT_IM PLUG_IN_INT_IM: USB plug in event interrupt mask reset by power down or RST.

**PMIC\_INT\_STS2**

Address: Operational Base + offset (0x00fc)

Bit	Attr	Reset Value	Description
7	RC	0x0	CHRG_BAT_HI_INT CHRG_BAT_HI_INT: BAT HI interrupt. reset by power down or RST.
6	W1C	0x0	BAT_OVP_INT BAT_OVP_INT: BAT OVP interrupt. reset by power down or RST.
5	W1C	0x0	CLASSD_OCP_INT CLASSD_OCP_INT:CLASS D OCP interrupt. reset by power down or RST.
4	W1C	0x0	CLASSD_MUTE_DONE CLASSD_MUTE_DONE_INT:CLASSD_MUTE_D ONE interrupt. reset by power down or RST.
3	W1C	0x0	CODEC_PO_INT CODEC_PO_INT: CODEC ANTI-POP DAC SMART POWER ON DONE interrupt. reset by power down or RST.
2	W1C	0x0	CODEC_PD_INT CODEC_PD_INT: CODEC ANTI-POP DAC SMART POWER OFF DONE interrupt. reset by power down or RST.
1	W1C	0x0	TS_GPIO_INT TS_GPIO_INT: TS_GPIO PIN input signal posedge or negedge interrupt. reset by power down or RST.
0	W1C	0x0	GATE_GPIO_INT GATE_GPIO_INT: GATE_GPIO PIN input signal posedge or negedge interrupt. reset by power down or RST.

**PMIC\_INT\_MSK2**

Address: Operational Base + offset (0x00fd)

Bit	Attr	Reset Value	Description
7	RW	0x0	CHRG_BAT_HI_INT_IM CHRG_BAT_HI_INT_IM:BAT HI interrupt mask. reset by power down or RST.
6	RW	0x0	BAT_OVP_INT_IM BAT_OVP_INT_IM:BAT OVP interrupt mask. reset by power down or RST.
5	RW	0x0	CLASSD_OCP_INT_IM CLASSD_OCP_INT_IM:CLASS D OCP interrupt mask. reset by power down or RST.

Bit	Attr	Reset Value	Description
4	RW	0x0	CLASSD_MUTE_DONE_IM CLASSD_MUTE_DONE_IM:CLASSD_MUTE_D ONE interrupt mask. reset by power down or RST.
3	RW	0x0	CODEC_PO_INT_IM CODEC_PO_INT_IM:CODEC ANTI-POP DAC SMART POWER ON DONE interrupt mask. reset by power down or RST.
2	RW	0x0	CODEC_PD_INT_IM CODEC_PD_INT_IM:CODEC ANTI-POP DAC SMART POWER OFF DONE interrupt mask. reset by power down or RST.
1	RW	0x0	TS_GPIO_INT_IM TS_GPIO_INT_IM: TS_GPIO PIN input signal posedge or negedge interrupt mask. reset by power down or RST.
0	RW	0x0	GATE_GPIO_INT_IM GATE_GPIO_INT_IM: GATE_GPIO PIN input signal posedge or negedge interrupt mask. reset by power down or RST.

**PMIC\_GPIO\_INT\_CONFIG**

Address: Operational Base + offset (0x00fe)

Bit	Attr	Reset Value	Description
7	RW	0x0	GATE_GPIO_IO GATE_GPIO_IO: GPIO IO definition 0: Input 1: Output, pull high to VCC_RTC
6	RW	0x0	GATE_GPIO_DATA GATE_GPIO_DATA: if GATE pin is GPIO function, it's the data buffer
5	RW	0x1	GATE_GPIO_FUN GATE_GPIO_FUN: GATE pin function 0: GATE function 1:GPIO function
4	RW	0x0	TS_GPIO_IO TS_GPIO_IO: TS GPIO IO definition 0: Input 1: Output, pull high to VCC_RTC
3	RW	0x0	TS_GPIO_DATA TS_GPIO_DATA: if TS pin is GPIO function, it's the data buffer

<b>Bit</b>	<b>Attr</b>	<b>Reset Value</b>	<b>Description</b>
2	RW	0x0	TS_GPIO_FUN TS_GPIO_FUN: TS pin function 0: TS function 1:GPIO function
1	RW	0x1	INT_POL INT_POL: INT pin polarity 0: active low 1: active high reset by power down or RST.
0	RW	0x0	INT_FC_EN INT_FC_EN:interrupt watchdog function enable 0:disable 1:enable reset by power down or RST.

Rockchip Confidential

## Chapter 6 Thermal Management

### 6.1 Overview

For reliability and operability concerns, the absolute maximum junction temperature of RK817 has to be below 125°C.

Depending on the thermal mechanical design (Smartphone, Tablet, Personal Navigation Device, etc), the system thermal management software and worst case thermal applications, the junction temperature might be exposed to higher values than those specified above.

Therefore, it is recommended to perform thermal simulations at device level (Smartphone, Tablet, Personal Navigation Device, etc) with the measured power of the worst case UC of the device.

### 6.2 Package Thermal Characteristics

Table 6-1 provides the thermal resistance characteristics for the package used on this device.

Table 6-1 Thermal Resistance Characteristics

<b>PACKAGE (QFN7X7-68)</b>	<b>POWER(W)</b>	$\theta_{JA}(\text{°C/W})$	$\theta_{JB}(\text{°C/W})$	$\theta_{JC}(\text{°C/W})$
RK817	2	21.99	12	6.58

Note: The testing PCB is based on 4 layers, 114mm x 76 mm, 1.6mm thickness, Ambient temperature is 85°C.